



**SHAREBOT**

---

**Next Generation**

DESKTOP 3D PRINTER





**SHAREBOT Next Generation**

**USER'S MANUAL**



**ATTENTION – EXTRUDER**

The fusion and extrusion system of the thermoplastic filament requires a heated end up to temperatures of 250 degrees and more. The contact, even for a very limited time, with the heated part causes burns. You must avoid to put your hands or other body parts in the printing area when printing and for minutes after the printing process is over. The current temperature of the extruder is indicated on the LCD screen.

**ATTENTION – HEATED PRINTING BED**

All the printing plate is made of metal with the addition of a glass plate. Shartebot NG may have a heater at the pot's bottom depending by which printer you decided to purchase. This device is electrically heated and serves to bring to desired temperature the entire printing bed, including the glass plate attached with pegs.

The temperature is measured directly on the heating plate: so the temperature of the glass plate will be less than the one shown for several minutes after the beginning of the heating process, but likewise it may be warmer than what is indicated on the display for several minutes after the end of the printing due to the the phenomenon of thermal inertia. If you have the heated bed, remember that it can be set in special cases for temperatures of 90-110 degrees, while the recommended temperature for prints is usually 60-70 degrees. At these temperatures the unintentional contact does not produce damage and burns if you retract immediately the body part that is in contact, while at higher temperatures it greatly reduces the time necessary to create burns. You have always to check the temperature indicated on the display before you start maneuvering like the posting of printed piece or the removing of the glass plate on the printing bed.

<b>Avvertenze</b>	5
<b>Summary</b>	6
<b>Chapter 1 – Preliminar operations</b>	12
<i>Anatomy of Sharebot NG</i>	
<i>Open the package</i>	
<i>Positioning the printer</i>	
<i>Assembling the reel-carrier</i>	
<i>Unlocking the extruder</i>	
<i>“Parking” second extruder</i>	
<b>Chapter 2 – Process of 3D Printing</b>	19
<i>Model</i>	
<i>Downloading from internet</i>	
<i>From a 3D model to a printing file</i>	
<i>A good STL, a good slicing, a good print</i>	
<i>Printing file</i>	
<i>Storing the files</i>	
<b>Chapter 3 – LCD Panel</b>	24
<i>Informative mode</i>	
<i>The control knob</i>	
<i>Access to principal menu</i>	
<i>“Prepare” menu</i>	
<i>“Adapt” menu</i>	

<b>Chapter 4 – Setting the printer</b>	28
<i>Loading the filament</i>	
<i>Preparing the printing plate</i>	
<i>Learning to set up the plate</i>	
– <i>Manual Calibration</i>	
– <i>Automatic Calibration</i>	
– <i>Regulating final leg of axis Z</i>	
<i>Calibrating axes X and Y</i>	
– <i>Recovering of scraps and usage of M99</i>	
– <i>Squaring off axes X and Y</i>	
<i>Putting in tension the extruder’s rubber bands</i>	
<b>Chapter 5 – Our first print from a SD Card</b>	34
<i>SD Card</i>	
<i>Printing profiles</i>	
<i>Starting the print</i>	
<i>Stopping the print</i>	
<i>Modifying printing parameters</i>	
<i>Detaching the 3D printed object</i>	
<b>Chapter 6 – Creating G-Code files</b>	39
<i>Slic3r</i>	
<i>Configuring Slic3r</i>	
<i>Loading the model to print</i>	
<i>Basicl parameters of Slic3r</i>	
<i>Slicing</i>	

<b>Chapter 7 – Material and printing plate</b>	43
<i>How ABS entails</i>	
<i>How PLA entails</i>	
<i>How other materials entail</i>	
<i>Heated printing plate</i>	
<b>Chapter 8 - Considerations about the model orientation</b>	46
<i>Orientation</i>	
<i>Just one object?</i>	
<i>Supports</i>	
<i>Printing details</i>	
<b>Chapter 9 – Double extruder</b>	50
<i>Calibrating second extruder</i>	
<i>Central clamp</i>	
<i>Offsets</i>	
<i>Refining axes X and Y</i>	
<i>Modifying the profile with Slic3r</i>	
<i>Positioning the locking printing bed rubber bands</i>	
<b>Chapter 10 - Ordinary manutention</b>	54
<i>Cleaning the printer</i>	
<i>- Printing bed</i>	
<i>- Stretcher</i>	
<i>- Nozzle</i>	
<i>Lubrification</i>	
<i>Putting in tension the belts</i>	
<i>A correct ventilation</i>	
<i>Updating the firmware</i>	
<b>Chapter 11 – General information about security</b>	56



## Support Policies

If you have any problems in using our printers, the procedure to be followed is as follows:

Check the manual and guides available on the web site;

Contact the dealer from which you purchased the machine

Contact technical support by filling out the form beside remember to fill in all fields. Our technicians will ricontatteranno within 3 working days.

In case your printer should re-enter in the factory to be repaired, our technical support will give assign a file number to return and we will provide all the additional information required.

Attention: the package should be the original one, penalty forfeiture of the guarantee

Upon receiving your printer, our technicians will assess whether the problem stems from a failure, in this case the repair under warranty will be carried out for free, or by improper use of the printer or by an improper use of material not approved by Sharebot: in the latter case we will provide you with a quote to request your consent to repair. For out-of-warranty printers may be required a quote for the inspection.

Troubleshooting is a very important task for us and we think is necessary to share experiences, problems and solutions. Because of that please give priority to the use of the forum that will also allow others to take advantage of our and your efforts. Each month we will evaluate who gave the best suggestions or reporting an issue with its solution, we will reward with a surprise! Visit our website for more information.

If you are interested in customized assistance programs please contact *info@sharebot.it*



## Technical characteristics

Printing technology: **Fused Filament Fabrication**

Mono extruder printing volume: **250 x 200 x 200 mm +/- 5mm**

Dual Extruder printing volume (mono-extruder objects): **210 x 200 x 200 mm +/- 5mm**

Dual extruder printing volume (dual-extruder objects): **180 x 200 x 200 mm +/- 5mm**

Theoretical positioning resolution axes X and Y: **0,06 mm**

Positioning resolution axis Z: **0,0025 mm**

Extruder hole diameter: **0,35 mm**

Filament to be extruded diameter: **1,75 mm**

PLA best extruding temperatures: **200-230°**

ABS best extruding temperatures: **220-250°**

Supported and tested printing filaments: **ABS, ABS Plus, PLA, Nylon, Termoplastic Polyurethane (TPU), Polystyrene, Cristal Flex, PLA Sand, PLA Flex, PLA Thermosense, PET**

Suggested printing filaments: **PLA**

Maximum temperature heated printing bed: **90°**

External Dimensions: **450 x 450 x 500 mm**

Weight: **14kg**

Consumption: **250 watt**

**Electronical card compatible with Arduino Mega 2560 with Firmware Open Source**

**Marlin <https://github.com/Sharebot3D/Marlin>**

**LCD Screen of 20 x 4 with an encoder menu of navigation**

**Presettet printing values fo ABS e PLA**

**Extruder block with regulation pressure upon filament**

**Double extruder could be pulled back**

## Chapter 1

---

### Preliminar Operations

#### Anatomy of a Sharebot NG

Your professional 3D printer Sharebot Next Generation is a tool of precision, ideated, developed and assembled in Italy by qualified staff. Before leaving the factory it was submitted to a quality control and to a quality test that guarantees its operation. It's very important, before you can use the printer, knowing all the technical terms used in this handbook and identify all the specific components that form a Sharebot NG.

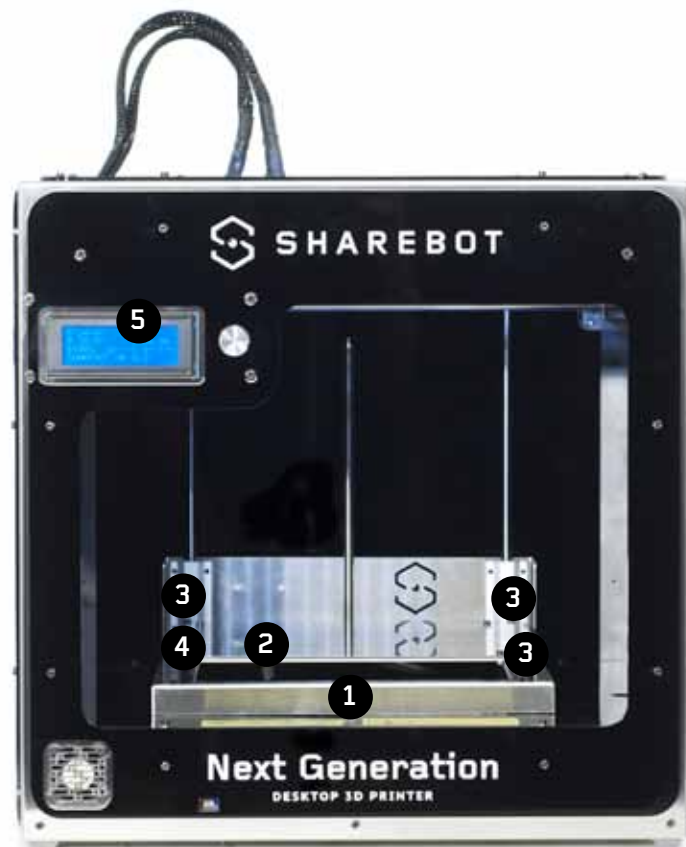

- 
1. Carriage of axis Z
  2. Glass printing bed
  3. Printing bed rubber bands
  4. Printing bed regulation screws
  5. LCD Panel
  6. Rotate and click control knob
  7. Extruder's cables

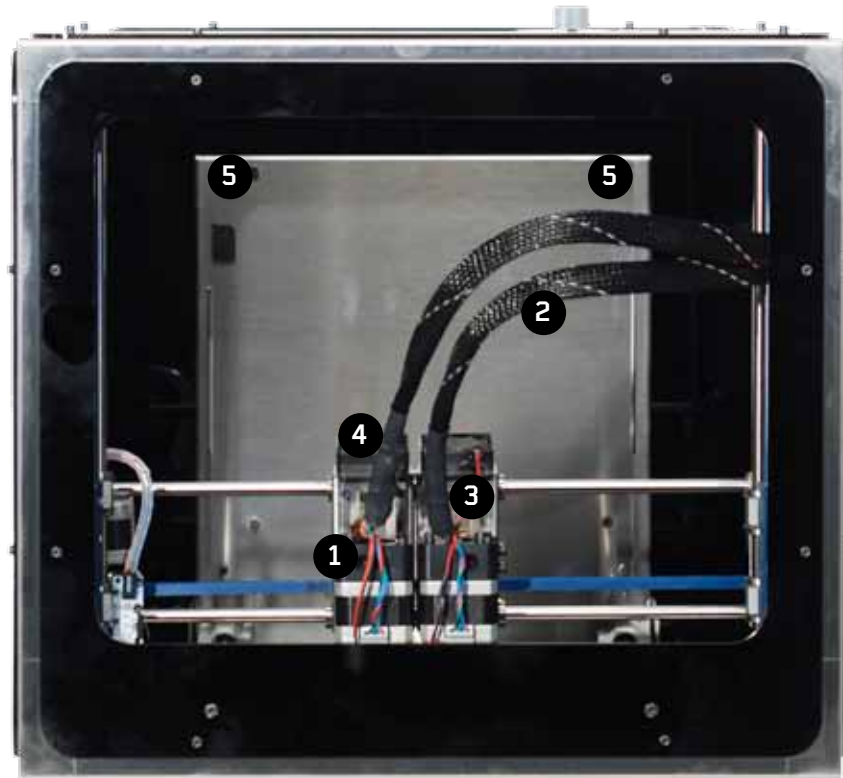

- 
1. *Extruder*
  2. *Extruder's cables*
  3. *Printing strand's power hole*
  4. *Material fan of cooling*
  5. *Printing bed regulation screws*



---

1. *SD Card entry*



- 
1. *Power cable socket*
  2. *Power switch*
  3. *Label with Identification Code*

## Opening the package

Your Sharebot NG is equipped with a series of accessories that allow you to make it immediately operative; there is no software because it is open source and constantly updated. Software must be downloaded from the website of Sharebot to always have the latest version.

With care and without damaging the packaging remove the various parts and elements that fix the printer inside the cardboard and then, by the internal metal frame, pull it out.

Do NOT pull the soft black lead from the left side and comes to the extruder: it is a power cord and NOT handle. Proceed with the recovery from the packaging of all the parts and check that the material listed below are all in the package:

Warning:

Do not throw away the original package. You could use it if you have to send it or move it.

In the package you'll find:

1. *Reel-carrier in assembly kit*
2. *Power cable*
3. *SD Card with a few object that we loaded for you*
4. *USB cable*
5. *100g of ABS and 100g of PLA*
6. *Spay*
7. *Cutter*
8. *Wire cutter*
9. *Warranty*
10. *Our letter of presentation and welcome*
11. *Glass printing bed and an object that we printed with your printer as a test*

## Positioning the printer

For proper operation, the printer must work in a clean and dust-free, with an ambient temperature between 5° C and 35° c. It is also preferable to a position away from drafts or air conditioning.

In the back you'll find power switch so we recommend to leave it easily accessible while at the front, bottom left, you will find the ventilation opening electronic part from which depends the correct circuit cooling: this must be left unobstructed.

Remember that the wire is usually in a spool and that this should be positioned on the reel-carrier included in the packaging. The recommended position is behind the printer, on the same floor, but there are alternative positions that depend on the presence of any walls or shelves near the machine. The important thing is that the wire is easily accessible and you can even put multiple spools on the



reel-carrier without any hindrances or preventing the entrainment of the wire by the extruder. For this reason, the printer may not be placed on a shelf that is at least 35 cm free space around the rear or side.

### **Assembling the reel-carrier**

The two sides of the triangle shaped and coils are identical; start with the screw on a nut on one side of the threaded bar, leaving 15mm of thread and repeat on the other side. Now insert the threaded bar on the shoulder using the hole on the top of the triangle and fix it with the nut. Do not overtighten to avoid breaking the plexiglass. Insert the reel and attach the second shoulder. Place the door coils behind or sideways into the printer recalling that the wire must carry out unhindered and in the direction of the extruder.



### **Unlocking the extruder**

To avoid damage during transport, the blocking of the extruder is secured with clamps. The clamps must be carefully cut and removed to allow the extruder to move freely. DO NOT feed the printer until you have done this step otherwise you will damage the motors and mechanics.

Remove all packaging inside the machine.

### **Parking second extruder**

If you have purchased a NG with double extruders this operation is crucial to the success of your prints; loosen the allen screw on the plate that connects the two carriers, we can move in parking position (to the left) the second extruder, which will be coated in the left shoulder by a magnet. This operation is essential to perform calibration.

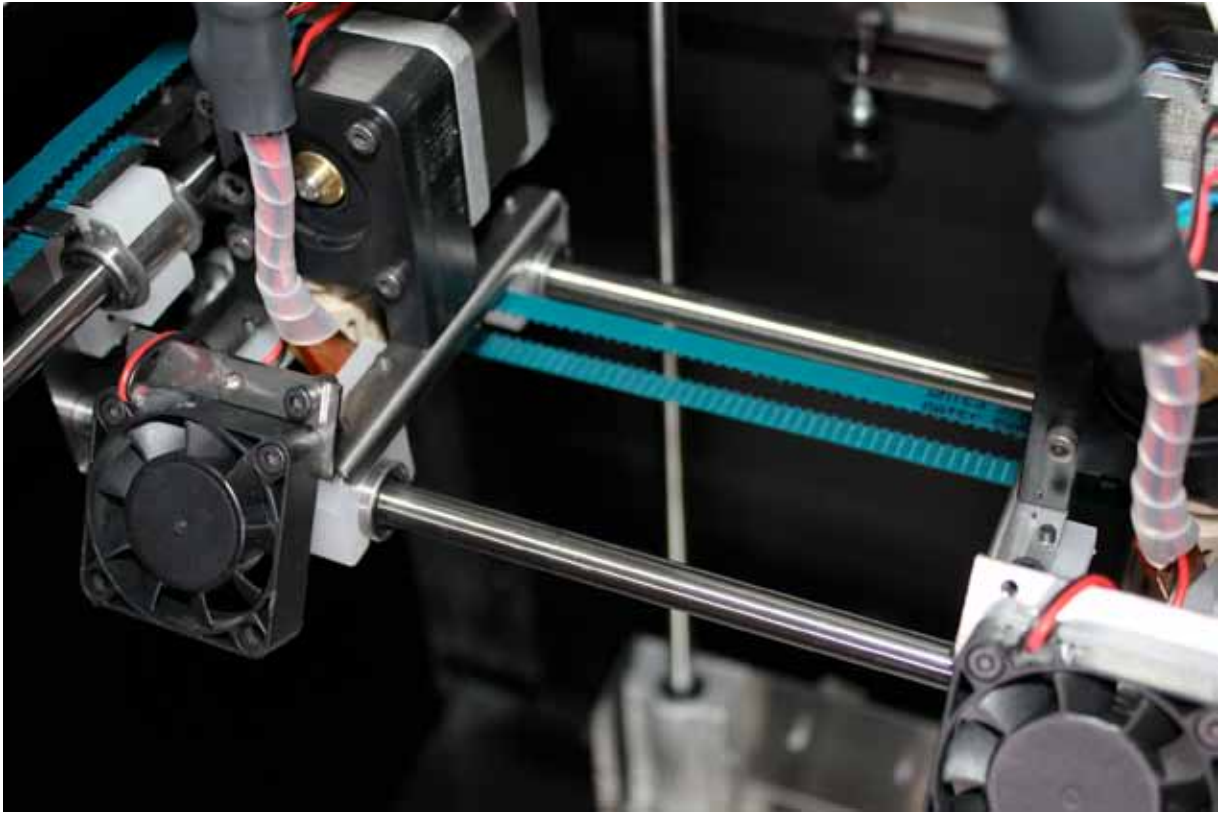

## Chapter 2

### Process of 3D Printing

Before you start printing with your Sharebot NG it is important to understand how you arrive at a finished object. This allows you not only to know what you need to do to give form and substance to your ideas, but it helps you to identify any constraints and limitations of the technology used by this printer.

In the table we summarized the steps required to obtain a 3D printing:

<i>Working enviroment</i>	<i>Operation</i>	<i>Output</i>
Common used CAD software	Design the object	Common used format for your file
Common used CAD software	Import/save file in .stl format (or .obj)	File .stl
Software: Slic3r	Generate command file for 3D printer	File .gcode
3D printer: Sharebot NG	Select file and preloaded filament profile filament profil	Printed object

#### Model

It all starts with creating or downloading a three-dimensional model of the object that you want to print in 3D. The creation is done through one of the many modeling programs available over the internet as freeware, shareware or software for a fee. There are many and each of them has specific characteristics. In this respect it is worth noting that you can have different modeling requirements and this is reflected in the variety of applications. Some are more suited to mechanical design, other artistic modeling, other than architecture.

Remember that 3D modeling was primarily used to create projects or for rendering. In the first case the model was thought to be accomplished physically and therefore is subject to a series of specifications and constraints that allow the project to be turned into something real. In the latter, the aim is to create an image for certain requirements: the model might then be flawless as display but physically impossible.

When you choose the program that you want to use for your models you must then ensure that it is able to create a file suitable for the production (especially 3D printing) so those programs that offer features of rendering or animation driven.

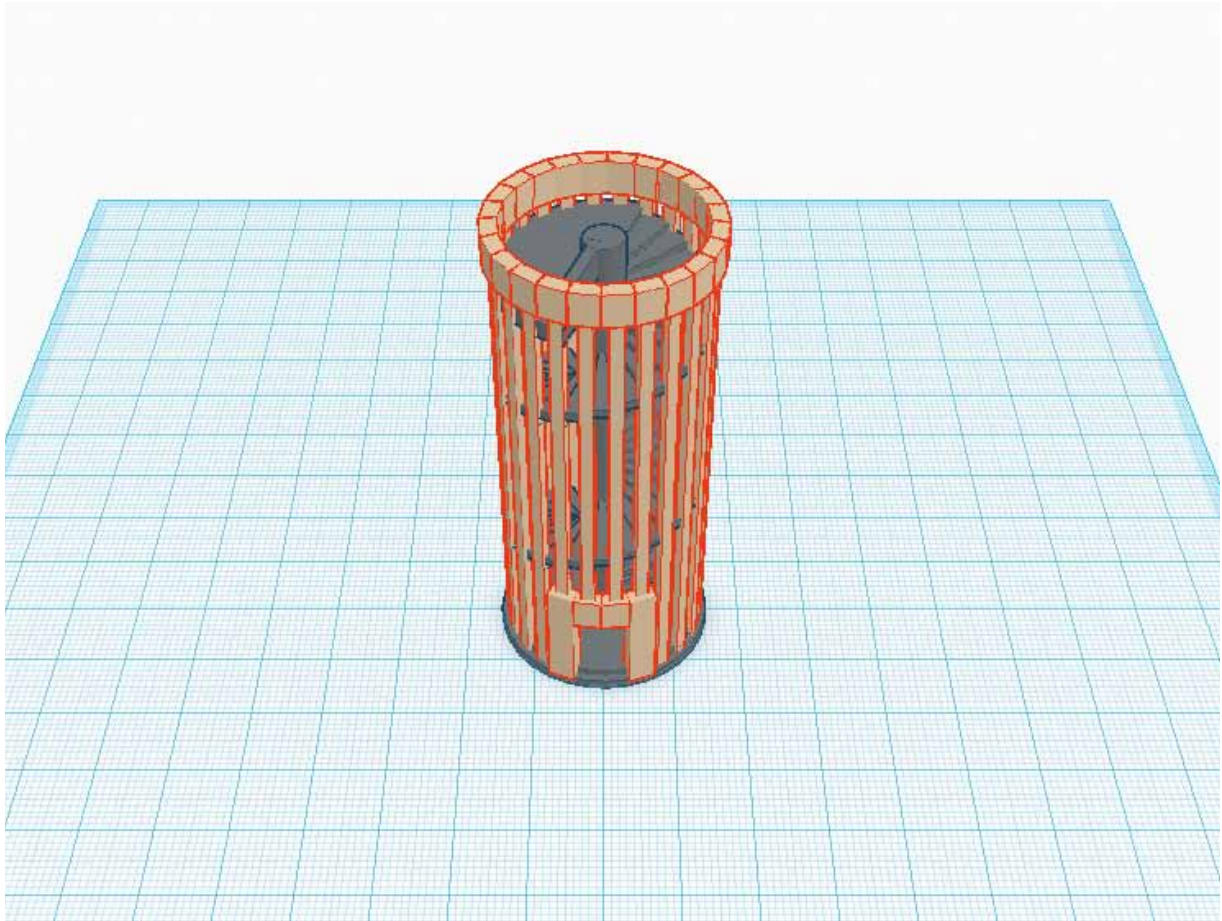

### Downloading from internet

The net offers many ready-made 3D models, but also in this case there are differences between the models that you “see fine” and those who “print well”. A good indicator of the ability to print the pattern is of the form: the most popular 3D printing is STL (sites that intend to offer printable objects use this format). If there is no STL it is likely that the intended use is different and the result on a 3D printer is not guaranteed.



### **From a 3D model to a printing file**

The real “secret” of three-dimensional printing is the transformation of three-dimensional object into a sequence of two-dimensional slices that overlapping, reconstruct the object. Imagine a series of slices of bread: If the stack rebuilt the loaf from which they were cut.

In the case of 3D printing every slice may consist of two-dimensional shapes not connected together as it is their sum to create the finished object.

Thanks to this breakdown, the object can be complex as desired because the printer will draw with the plastic one layer after another without overlap; a square or a doodle for the printer have the same difficult.

The most important work the software makes is starting from the 3D model – usually a mesh of triangles in space called mesh – and transforms it into a sequence of slices according to a number of parameters (slicing). Because the process is completed correctly the mesh should be closed and not have triangles that are oriented incorrectly confusing the “inside” and “outside”. It happens that some model is made to art: at this point or the software that does the slicing manages to repair the mesh or the result of errors that will prevent the correct reproduction of the object.

### **A good STL, a good slicing, a good print**

The STL file is the starting point for the entire procedure, so from the file should be removed anything you don’t want to print (hidden objects, etc.).

The 3D drawing must be a solid and not a solid sum interpenetrate or match. Similarly, the design must be as clean and precise as possible: articles must have an inside and an outside well defined so that the surfaces perfectly match each other without leaving holes. most 3D design software gives you the possibility to carry out an analysis of borders to check for holes.

The 3D drawing must be oriented in such a way as to have a face adjacent to the XY plane of your drawing software: in other words, the design should not “float in a vacuum”, otherwise the machine will not print.

If you’re working on a STL downloaded from internet or given to you by a client, there are free software for checking and correction of STL as Netfabb.

The “slices” are printed in a specific format (called G-Code); This format is nothing more than a set of instructions for moving the instrument (cutter, laser or extruder head) along a path X, Y, and Z axes. Each slice contains the movements on two axes, moving the press plane and motor commands that extrudes the molten plastic to create one after another the layers that make up the object. At the end of each layer file commands move the Z-axis by lowering the print of that plan just enough to add the new layer.

Every 3D object can be transformed with the process of slicing in a variety of G-Code files, each different from the others because slicing parameters generated using different: for example the slices have

the inside full, empty or partially empty, or the walls are made with one, two, three or more passes. Even the thickness of each layer is one of the parameters. The same object can be printed full, empty, with 100 or 200 slices and more or less robust and stiff despite having all versions a similar appearance.

## Printing file

The G-Code files, containing instructions for navigating the various mechanical parts of the printer according to specific parameters and settings has a limited compatibility between different printers. While the STL file of the template can be used by anyone with a 3D printer to create a printing G-Code, a G-Code files is definitely running for the printer for which it was created but could be unusable with other printers. If it is not clearly compatible with NG Sharebot there try to print files that you find on the net because they may have malicious entries to your printer.

The file also contains the heated printing bed temperatures and those of the extruder, tying the file not only to the printer but also to the material to be used. As we shall see in the following pages, with the LCD Panel it is possible to modify some parameters when printing: Sharebot NG offers you the possibility to edit the G-Code in order to adapt it to different materials without having to redo the process of slicing.

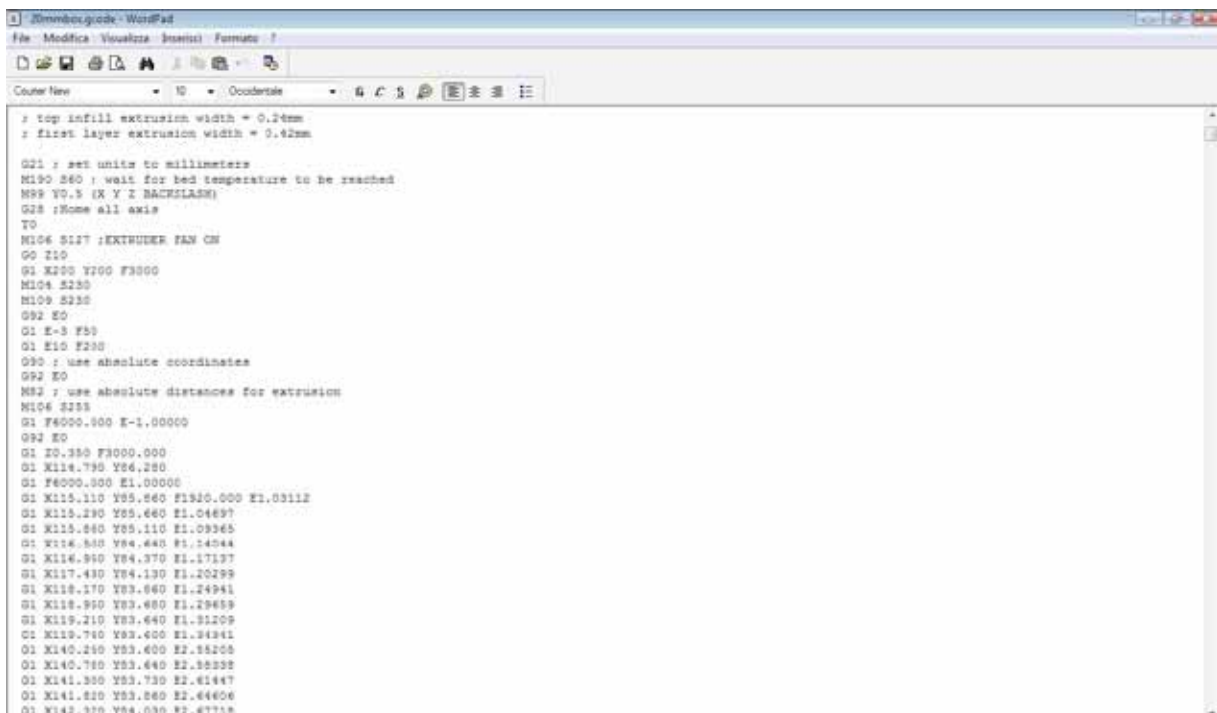

```

; top infill extrusion width = 0.24mm
; first layer extrusion width = 0.42mm

G21 ; set units to millimeters
M190 S60 ; wait for bed temperature to be reached
M99 Y0.3 (X Y Z BACKLASH)
G28 ;Home all axis
T0
M106 S127 ;EXTRUDER FAN ON
G0 Z10
G1 X200 Y200 F3000
M104 S230
M109 S230
G92 E0
G1 E-3 F50
G1 E10 F200
G90 ; use absolute coordinates
G92 E0
M82 ; use absolute distances for extrusion
M106 S230
G1 F6000.000 E-1.00000
G92 E0
G1 Z0.350 F3000.000
G1 X114.790 Y04.280
G1 F6000.000 E1.00000
G1 X115.110 Y05.660 F1910.000 E1.03112
G1 X115.230 Y05.660 E1.04497
G1 X115.360 Y05.110 E1.03945
G1 X116.640 Y04.640 E1.04044
G1 X116.960 Y04.370 E1.17137
G1 X117.430 Y04.130 E1.20289
G1 X118.170 Y03.660 E1.24941
G1 X118.960 Y03.660 E1.29659
G1 X119.210 Y03.640 E1.31209
G1 X119.740 Y03.600 E1.34341
G1 X140.240 Y03.600 E2.95200
G1 X140.760 Y03.640 E2.98332
G1 X141.300 Y03.730 E2.61447
G1 X141.820 Y03.860 E2.64600
G1 X142.320 Y04.030 E2.67712

```

### **Storing the files**

As we have seen, the process consists of the stages of modeling, creation of STL files, slicing into a G-Code file and print. We recommend that you save the template file in the native format of the 3D modeling program, so as to keep any primitives that compose the object. Similarly the STL files should be stored in order to make slicing with different parameters, and finally we suggest you save the G-Code, even in different versions for the same model, so you can repeat a print with specific features using the G-Code files that you already know the final result.

## Chapter 3

---

### LCD Panel

Sharebot NG is a printer that supports both stand-alone operation and control from one computer (OS X, Windows or Linux). In both cases the LCD Panel provides functions both for consultation which edited.

#### Informative mode

When the printer is on, he is by printing or waiting for a job, has about 20 rows to 4 characters with the following information:



The first line contains the actual extruder temperature followed by one set; If the extruders are two, the first is on the left while the latter is right. What is used as the primary extruder is the one on the right. The temperature is in degrees Celsius.

The second line indicates left the temperature of heated plate with a left sidebar and current temperature right one set; right in the second row is the current position of the print, or z-axis. The value is in millimetres, with two decimals indicate hundredths of millimeter.

The third row has left the percentage Rate or Feed than expected print speed within the G-Code files (and then set as a parameter of slicing) is increased or decreased in percentage. The 100% does not alter the speed of movement set; lower values will slow down the speed and higher values increase the speed.

On the same line in the Center is the percentage for printing a file on SD card: start with 00% at the beginning of the press to get to 100% when printing is completed. To the right of this is the elapsed time from the start of printing, expressed in hours and minutes.

The fourth line contains messages that can be generated by the G-Code file with a special command, or the firmware of the card of specific situations.



### **The Control knob**

To the right of the display is a knob which rotates with small clicks and can be pressed as a button. With this knob you can interact with Sharebot NG: clockwise you decrease the selected value, turning it anti-clockwise will increase.

During menu scrolling, rotation anticlockwise flows downward, that hourly rate upward.

When the display is on the screen information, described at the beginning of this chapter, the rotation of the knob acts on Feed Rate percentage, increasing or decreasing the speed of all the movements and therefore also the printing speed.

### **Access to principal menu**

Pressing the knob of the screen information, accessing the main menu. Remember that the menu displayed depends on the State of the printer if it is waiting to run a business, offers the menu “prepare”, while if you are printing offers the menu “fit”. The voices and the features available in these two modes are different and it is important to know how you are to avoid to lose time looking for functions that are of other mode.

### **1° level active printer**

Main Menu

Prepares

SD Card Menu

Reset

### **1° level printer in print**

Main Menu

Adapt

Pause

Stops Printing

Reset

### **“Prepare” Menu**

This menu is used to set up and manage the printer for subsequent operations such as printing or shutting down. From here you can upload and download print, wire extruders, Preheat to 0.0 extruder positioning or movement of the extruder on the plane. In practice, you have complete control and can perform all management and maintenance operations. In the next chapter we will use this menu to adjust the printing surface.

Main Menu  
Disable engines  
Auto Home  
Preheats RX  
Preheats LX  
Cool  
Move Axes  
Calib. Printing bed Auto  
Calib. Printing bed Man.  
Change Wire RX  
Change Wire SX

### “Adapt” Menu

The item appears only when the printer is performing a job playing the G-Code, just by printing this article appears as first in the list when you press the knob.

Main Menu  
Speed  
Nozzle  
Nozzle 2  
Printing bed  
Fan  
Stream  
Change Filament

Inside there is an additional menu that allows us to vary the overall printing speed, expressed as a percentage and identical to the present as a feed rate information screen (velocity is the parameter which is varied by rotating the knob from the screen information). Below the set temperature for the nozzle (two nozzles in the case of dual-extruder printer): the value is in degrees Celsius and any change must be confirmed by pressing the menu knob. Same thing for the heated stage.

The next item is the fan speed, adjustable from 0 to 255; with very low values the fan may not even start to turn.

The stream value is relative to the percentage increment or decrement in material flow in the extrusion phase: slicing software calculates exactly how the material is extruded to create individual layers, but unforeseen changes or not declared in wire diameter than the given value as a parameter to the slicing could then request compensation and this entry serves for this purpose. A value of 100 corresponds to any variation of the flow of material, values less than 100 reduces the contribution of

material and higher values increase the extruded material from the value predicted by the G-Code. In all cases, it is a percentage.

The latest rumor concerning the change of the filament while printing: the procedure arises from the need to replace the filament out with a new reel for use until after the previous coil, but this item can also be used to change the color of the filament or even the same type of filament by maintaining the ability to continue printing without defects in the object.

The procedure starts with the shift of the extruder in parking area, then the engine expels the current thread and the internal buzzer is activated as soon as the extruder is unloading. When you have positioned the new wire on the inlet hole and you did it so I hit the drive sprocket you must press the knob to start dragging and extrusion which reloads the casting chamber and also allows you to expel the remnants of previous material. When the flow of new wire is satisfactory, press the menu knob again to resume printing.

### Setting the printer

Your Sharebot NG is a mechanical device built with care both in design and in the Assembly. To keep it in a State of optimal functioning is necessary to compensate for some normal processes of adjustment, for example, due to repeated thermal cycles of extruder motors and print heated dish.

With each press, the entire machinery is subject to vibrations and movements that in the long run can loosen the four screws that hold the glass by the press. This leads to not have more precise and uniform spacing of the glass plate from the extruder which inevitably fails to apply the first layer with the accuracy and uniformity necessary for quality printing.

Just exit out of the box, Sharebot NG should be even with the exact factory calibration, but a long journey or vibrations during transport may have done move some adjustment screw.

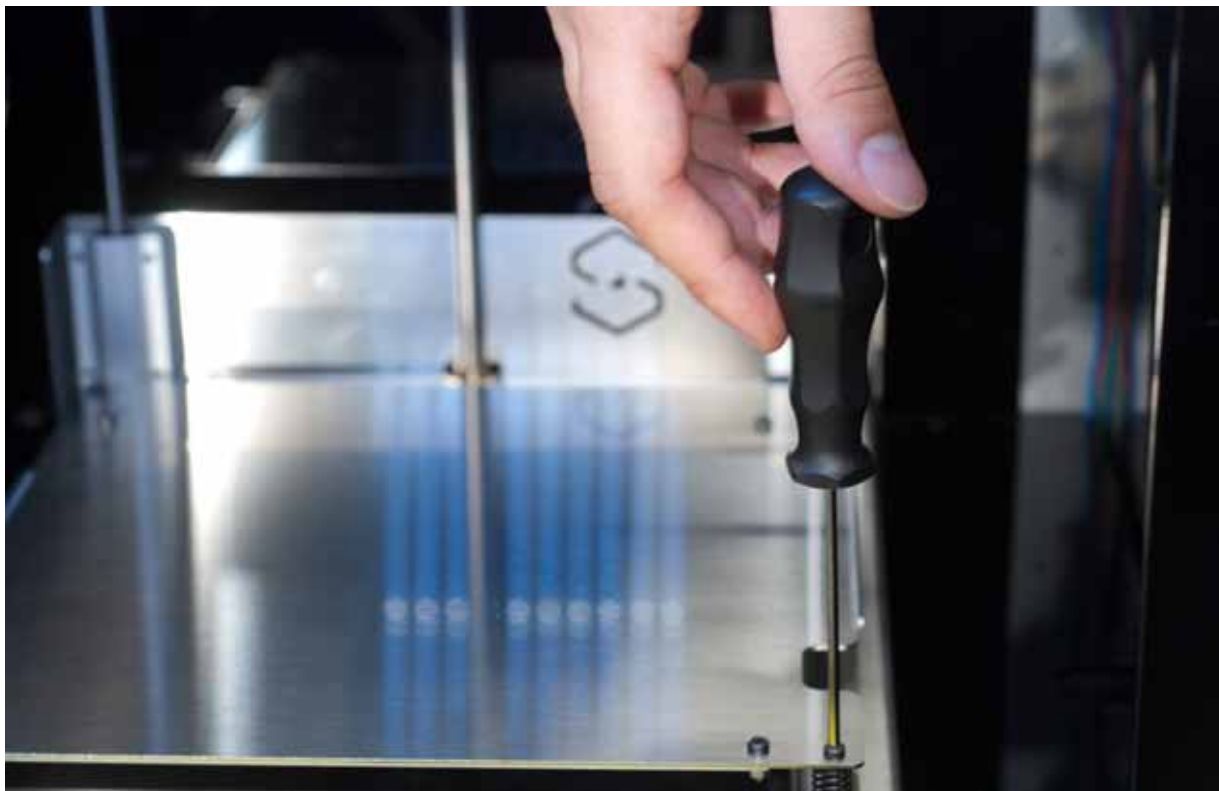

### Loading the filament

To be able to print you must load into the extruder thermoplastic wire that once pushed in heated room, becomes fluid and may be extruded. Sharebot NG has a specific menu item to load the filament and is located under the heading “Prepare”. When enabled, it starts heating the extruder and when the temperature is reached, you can load or unload the filament (the procedure is identical to that which is accessible from the menu “Adapt” described in the previous chapter). Cold extruder to the filament is locked and cannot be forced by pulling or pushing it into the extruder. To load the filament, oblique cut the plastic wire ends to form a bit and put it in the pusher, making sure that the wire runs, surpassing the sprocket and into the hole below.

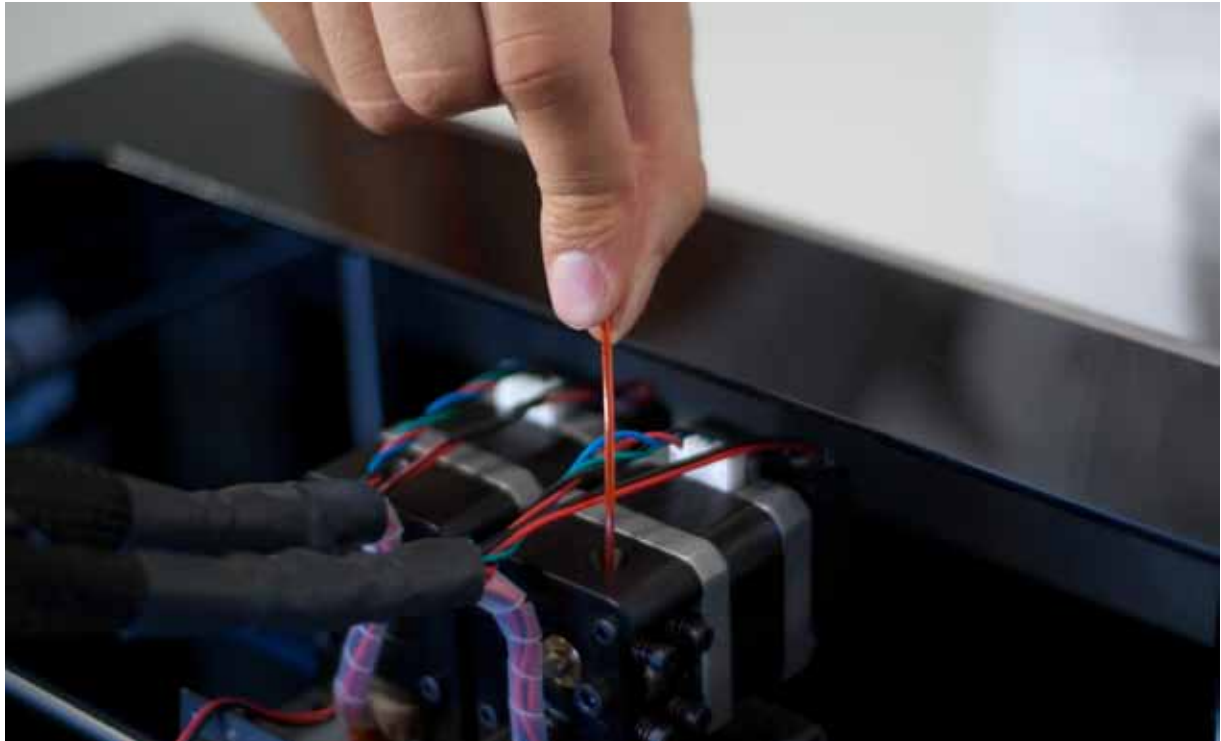

### **Preparting the printing bed**

We remove the clothespins from the glass and extract it from the printer. Sprinkle over a thin layer of spray evenly up to cover the entire surface (light you will have a shiny effect). Now we await the complete lacquer drying and glass are placed on printing and secure it with pegs. Never spray inside the printer because it means severely damage the mechanical movements of the same and consequently invalidate the warranty. After a series of prints or when the dish will have bumps or dirt residues dates of previous prints, estraerete the glass to wash it in lukewarm water in order to report the conditions under which it was when you bought the printer. Always pay attention when moved the glass plate.

Reposition the glass printing bed in the printer, with 2 clothespins block it as in figure below. The position of the pegs is not binding or final: pegs in blocking the glass invade useful print area, you can then change the position based on which in turn will be printed, so as not to find the clamp on the nozzle.

### **Learning to set up the plate**

This, though initially a bit laborious, will become for you a habit that you do before every printing quality, without this there commitments for more than a few seconds. With the experience you will be able to take action during the printing of the first layer in case you highlight any irregularities in thickness. In general, acquire the right to adjust the sensitivity of the press, even just looking at the front and at the floor and the extruder, it will be for you an advantage and potential always prints guarantee optimal.

Before you start any cycle of calibration, you should “parking” the second extruder on the left side of the printer and set it with the provided magnet. Automatic calibration cycles are designed to access all calibration screws with a single extruder.

### **Manual Calibration**

This operation should be carried out with the tip of the nozzle clean, residue-free material. For cleaning of the nozzle there refer to Chapter 10.

Manual calibration is intended to make a macroscopic adjustment of floor with a sheet of paper that should be positioned between the floor and the extruder.

When you enable this function, the plan is to “0” theoretical level and the extruder is positioned sequentially in the four corners of the press. Adjust the Allen screw clockwise to lower or counterclockwise to raise plan. Make sure that the sheet of paper (for example a bit clipped from an A4 sheet by laser printer) you stick with struggling between the glass plate and the extruder. Repeat the operation by pressing the knob to move the extruder on the next corner and remember that each adjustment on a corner effect, although slightly, on the other.

When the regulations will be ultimate extruder tip must brush against the print plan in all respects, without ever touching it.

### **Automatic Calibration**

Automatic calibration prints rectangles made with one layer on top, allowing you to assess the adhesion of the material to the press and to figure out if the plan is leveled properly observing the extrusion width must be equal at all points of the perimeter. A tight stretch indicates a greater distance between press and extruder plan (too low), while a sudden large discolored motto indicates a plane too high. Going to touch the tip of the screwdriver wrench strokes closer, you’ll notice that is a departure from the press: this is a further sign of a flat area that is too low.

This procedure provides an input into the function, and then with one click starts the warm-up and zeroing of the various coordinates; When the extruder is 230° starts the first rectangle. Considering the result you can intervene on the four screws at the corners and, after the adjustments, press on the knob to verify the result through the tracking of a second rectangle. After this round of tinkering, the machine draws a cross in the center of the rectangle to test the result.

### **Regulating final leg of axis Z**

There is also, for subsequent regulations that require only a rapprochement or removal of the nozzle, the ability to adjust the Z limit, running ahead or by delaying it. To adjust the limit switch intervention Z let’s turn the black knob on bottom of machine (see picture); clockwise increase the distance plate-nozzle going to decrease the total travel of Z, while turning it counterclockwise decrease the distance plate-nozzle, lengthening the total travel of Z.



### Calibrating axes X and Y

If printing your objects you find that the circles are not exactly round or that the joints, despite the necessary CAD drawn, tolerances don't fit together properly, it is probably necessary to calibrate the X and Y axes on your printer.

The possible X and Y calibrations on your ShareBot NG are of two types, software or hardware:

- *Recovering of scraps and usage of M99 (software calibration)*

If you have a scrap on a strap of one of the two axes you will recognize it by checking any hole or circle printed, as shown in the figure below.

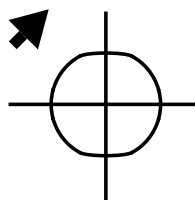
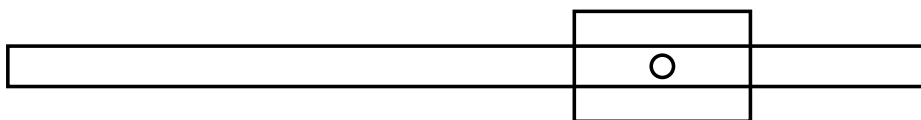

**Y BACKLASH**

Recognize the direction of the scrap, for example, if the flat part appears along the X axis (towards the front of the printer and printer), as shown in the figure above, it means that you have a game on the y-axis.

The first intervention is checking the tension of the belts on the axis with the game, after that you can act via software to correct the same.

In the start g-code of Slic3r or slicing software used enter the command `M99 Y0 Y0 .2 .2`, where stands for the game away to retrieve. You can enter the value and use the TEST from our downloadable gcode website to check the correct value to be inserted to make the game on the axis vanishes permanently.

#### - Squaring off axes X and Y (hardware calibration)

If your circles are ovoid or teams of the blocks (figure below) are not “squad” maybe you need to realign the print deck.

To verify that the X and Y axes are among their orthogonal, we can always use the file test. gcode downloadable from our website, which also contains the printing of some rectangles. Now measure the two diagonals of a rectangle printed: if they are together again we’ll have to go to work to put together the X and Y axes.

This procedure requires a certain dexterity and experience on machine: If you’re not sure about it we suggest you avoid it.

Prepare menu, select “Auto Home”; Now let us relieve the bugle that screw the strap on the left shoulder of the machine; at this point we slide a single tooth belt over his shoulder forward or backwards to correct the detected square; ritensioniamo the belt and repeat the test print.

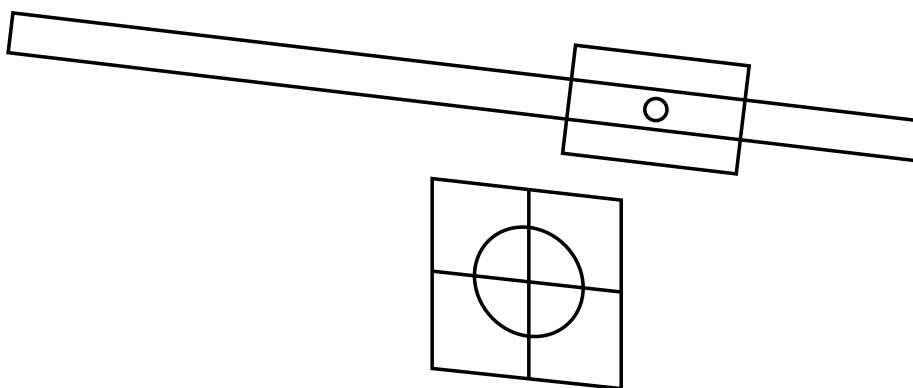

## Y CARRIAGE OUT OF ALIGNMENT



### **Putting in tension the extruder's rubber bands**

Your Sharebot NG is equipped with a cushioned versus pulley sprocket wire drag. This solution allows to compensate for thickness variations that some filaments can have, allowing you to bring the press anyway.

The correct tension of the compensating Springs allows optimum filament drive.

Select the display "Prepare" menu the option "Change wire". Wait until the machine ejector cycle terms and once finished, insert the wire. While loading try to lock the thread with your fingers; If this were to lead to a "slip" of the sprocket on the filament, tighten the springs until you have an outlet to blow away the engine (you should hear a ping like a tak tak). Similarly, the springs must not be too narrow to protect the motor is too under stress and consequently lose steps.

## Chapter 5

---

### La nostra prima stampa 3D

If you have followed the instructions in this manual, you've already developed your Sharebot NG by placing it on a table with door-coils, you connected the power supply, and you have turned on the printer, then the second extruder, scarrellato done the calibration plot and plan you have also uploaded the plot strand. Now you can proceed to your first print. If you have instead skipped some of the steps just listed, please go back and reread it before continuing.



#### SD card

In the box you find the plastic container with your SD memory card. On this tab you can write files into G-Code (see Chapter 2) that you want to print. Preloaded at the factory were some sample file, ready for printing, so you can make your first print knowing that the file has already been controlled with optimal parameters to get the best result.

#### Printing profiles

Theoretically every G-Code requires a specific material, determined by the values set by the temperature of the nozzle, heated floor temperature and fan speeds. To print the same object in different materials should then create separate files.

To work around this limitation, Sharebot NG allows you to select, before printing, the outline of the material that we use. In this way we can create generic G-Code to be printed with the chosen material simply by choosing the corresponding profile. In other words: we can not insert the various temperature parameters in slicing because they're set correctly when we choose the desired material profile.

#### Starting the print

Press the knob again to enter the menu, then choose "SD card menu". Now we have the opportunity to choose how the print launch profile: choosing "Normal" will print with the values set by us "upstream" slicing software; choosing the PLA will print profile with standard parameters of PLA and similar (extruder temperature: 220°, printing plate temperature 50°, 255 fans); choosing ABS profile we will launch the print with standard parameters of this material (extruder temperature: 230°, 90°

heated floor, fans turned off).

Once selected the profile displays the contents of the SD Card both in terms of file and folders. By turning the knob, you can scroll to the file you want. Pressing the knob you select for printing.

Your Sharebot NG will start with the heating phase and by positioning the origin of the axes, then when it reaches the temperature you do in a central area of the press and will start with the first layer. Check that the filament sticking to the floor without being crushed nor too, it only supported and then round. If you have successfully run the calibration you will have no problems; on the contrary it should stop printing and redo calibration.

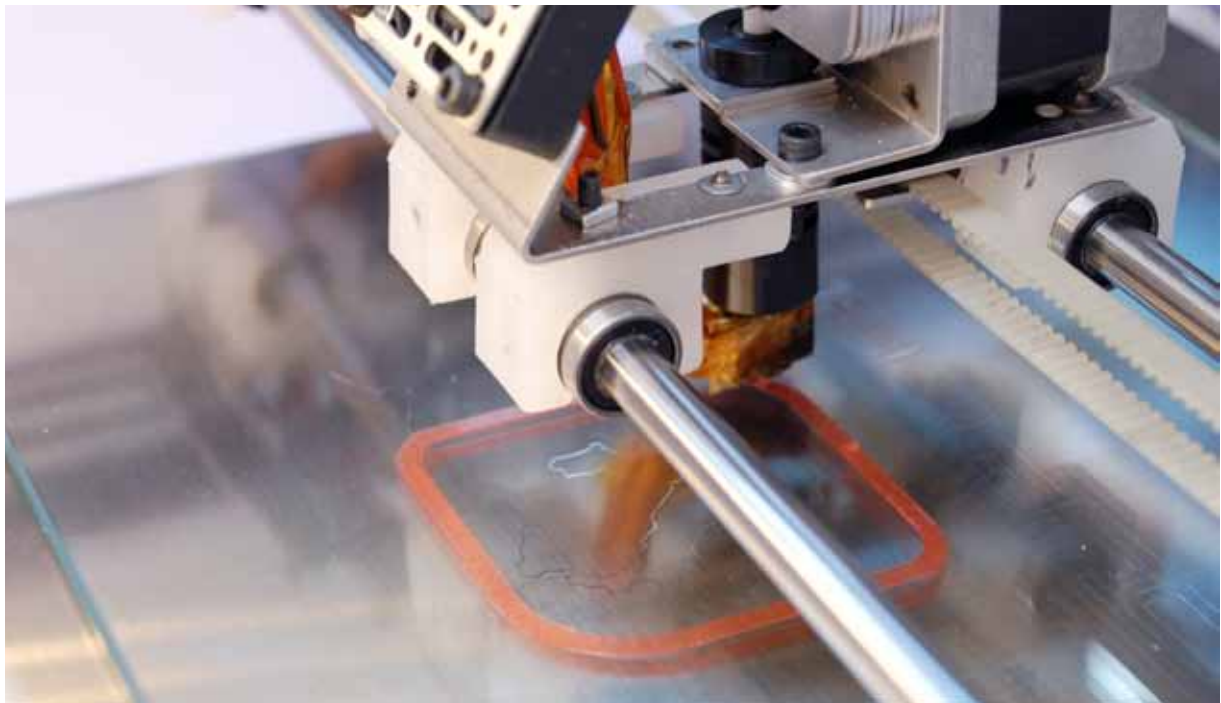

### **Stopping the print**

When printing you can pause or abort printing. The two options are available directly from the main menu as “Pause” and “Stop Press”.

Remember that in the first case is only blocked the process of creating the layers by stopping the extruder (this may take a few seconds) waiting for you give the command “Resume”.

In the second case the printing stops immediately and can no longer continue. The extruder is positioned at the beginning of the X and Y coordinates. Unfortunately, the point at which stops the extruder can be affected by heat and then deform or can a runny agglomerate of material from the extruder. So the break is to be used only in case of need and for short periods.

Please activate it only when the extruder being traced a fill so that the drop is hidden inside the object.



### **Modifying printing parameters**

One of the features of Sharebot NG is the ability to intervene on a number of parameters while printing is in progress.

The “Adapt” menu becomes available instead of the “Prepare” (see Chapter 3): This allows you to adapt the selected profile PLA or ABS or normal to their compatible materials for behavior and characteristics (v. Materials table in Chapter 7), changing the nozzle plate temperature and the fan speed. Speaking at the feed rate example you can slow down or speed up the overall printing speed to handle any contingencies as a material that requires more time to cool (and therefore should be printed more slowly) or a model that can be achieved at higher speed. Another important parameter is the flow rate that percentage increases or decreases the amount of material extruded, compensating for any changes in the diameter of the wire than that stated by the manufacturer. The flow rate can also thicken or thin the walls of the model.

The “Fan” makes it possible to adjust the airflow on the piece in print.

### **Detaching the 3D printed object**

Finished your print, Sharbot NG put the printing plate down and park your extruder. In this location there is easy access to print plan to detach from it the finished object.

This operation is delicate and inevitable: because the object is printed, it is necessary that its first layer adheres well and remains clinging to the plane for the duration of the press itself. If there was a

good seal, mechanical stress and just a little bit of shock on the extruder would jump away, ruining irreparably printing.

Detach the model thus requires a certain expertise, a thin spatula or large blade cutter.

Remember to place the maximum attention during the proceedings: we recommend wearing protective gloves to avoid cut with the blade or the glass plate.

In both cases you have to try to insert the blade of a few millimetres under one side of the printed piece, then with horizontal movement, without trying to lift the piece, you need to sink the blade toward the opposite side. Usually the piece blows away without too much force and without that we must arrive on the other side.

If the model has thin legs or parts you are looking for before you remove these without lift and then pull out the part with the broadest support. In this way you will avoid to break the thin parts. In the case of vessels or parts with a single wide base, start on one side, trying to insert the blade more in depth, but did not push directly, but with an oscillatory movement to advance the blade.



As advice, avoid using the same piece as an element to force (pulling) or lever (it) because it could break. If the printed object has a high surface you can remove the Print plate and place it under warm water, allowing the dissolution of Hairspray and a detachment of the piece easier.

Remember that just finished printing might have the printing plate and definitely the extruder tem-

peratures. The block of extruder solid brass remains for several minutes at temperatures sufficient to cause a burn. Look at the temperature on the display and absolutely avoid any contact with it if the value indicated is higher than 50 degrees. If in doubt, do not detach the piece until the temperature has dropped to safe levels before you put your hands inside the print area.

## Chapter 6

---

### Creating G-Code files

As well as modelling software, also for slicing software we have available a wide range of programs: from free and open source ones, until those paid professional.

Free ones, we have selected Slic3r as reference slicing software, for his versatility that makes it usable by both beginners and professional users.

#### Slic3r

By Alessandro Ranellucci, is an open source program slicing; is scaribile for free at [www.sharebot.it/download](http://www.sharebot.it/download). We recommend that you download the version 1.1.5, which at the time of writing of this manual is the latest stable version.

Finished downloading, unzip the folder and double click the icon “Slic3r”: the program will run without installation: we recommend that you create a shortcut on your desktop. During the first launch the program may ask you to set the data and the parameters of your printer: click “cancel” and loaded the Sharebot NG profiles as shown in the next paragraph.

#### Configuring Slic3r

As a first step, we recommend that you switch to expert mode: from the file menu choose “preferences” and, in the drop down menu select “expert”. To confirm the mode you need to close and restart the program.

At this point it is necessary to define the parameters for the printer. In order to simplify the process we have made available on the site, in the same section, download the printer profile Sharebot NG that we invite you to download. After that, choose “load config ...” from the File menu; in the folder “profiles” that you have already downloaded, select the file “SharebotNGDefault” and, once loaded, click on the diskette icon adjacent to the box with the name of the profile you just uploaded. You must repeat the save operation for each of the three tabs “Print Settings”, “Filament settings” and “Printer settings”. The profile will be available in future sessions only after saving, otherwise it will be available only for this session of “Slic3r”.

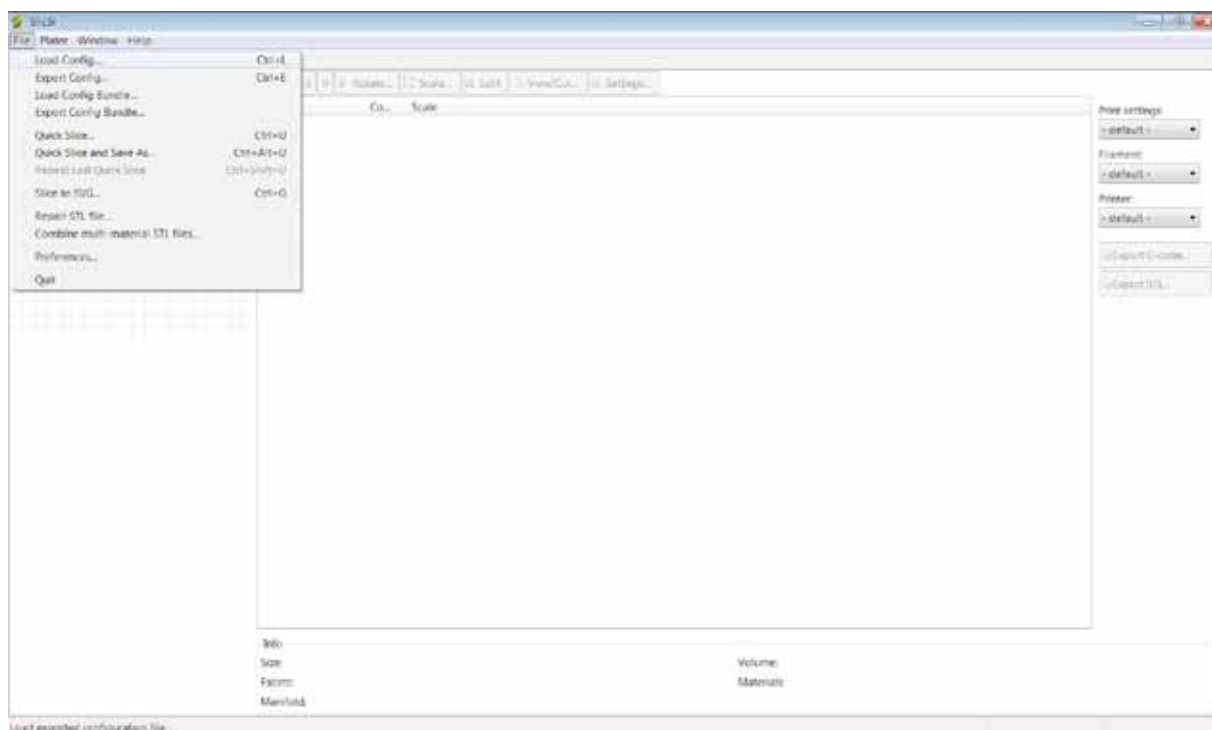

Just in case you have a dual-extruder and NG please make a double press extruder, load the profile “SharebotDualstrusion”. Otherwise unnecessarily heating energy sprechereste the second extruder. In the configuration file we included parameters related to all three tabs to allow you to have a starting point for reliable and experienced. If you want to create different profiles, you can adjust the individual parameters and save configurations with a new name. We recommend that you do not overwrite the basic profiles provided by Sharebot.

### Loading the model to print

In the tab “Plater” click on “Add” and upload your 3D model in STL format; Alternatively you can also drag it within the program from an open folder. Will Center automatically Slic3r file without lay it on printing: If your STL was created adjacent to the XY plane printing is doomed to failure.

You can upload multiple STL or upload multiple times the same STL doing what in jargon is called “im-piattato”. For the dailies we recommend you try one file at a time.

### Basic parameters of Slic3r

As seen earlier, Sharebot NG allows (thanks to profiles PLA and ABS) generating G-Code by setting only the geometric parameters of our interest: we can create not specific G-Code to individual materials, leaving then set all the parameters of temperature, fans, etc., to determine the material to be used.

From this perspective, the basic parameters are those that go to geometric illustrate.

For further information please see Slic3r manual ([manual.slic3r.org](http://manual.slic3r.org)) and our courses ([www.sharebot.it/academy](http://www.sharebot.it/academy)).



*Layer height:* inside the tab “print settings” in the menu “layers and perimeters” you will find the entry “layer height”; This is the height of single layer and determines the printing resolution (for z-curves) and, consequently, the printing time. The preset value is 0,2 mm and is a good compromise between speed and quality, but you can go up to 0.05 mm or growing up to 0.35 mm.

*Filling:* next menu “infill” the voice “fill density” expresses the percentage of filling the template. You can set values from a minimum of 5% to a maximum of 100%. This parameter will affect the speed of realization of printing, the lower the fill faster printing. Obviously with a low filling will have a lighter piece and brittle. For this the fill parameter can be varied depending on the outcome you want to achieve. The entry “fill pattern” lets you choose from a drop down menu the texture that you want to fill areas to the (straight, hexagonal, etc.).

*Supporting material:* in the menu “support material” you will be able to select the menu item “support generated material” and the program automatically will undercut zones (zones of suspended model or having the upper 45° inclination) of the support towers.

Before you select this option, you should read the credits in Chapter 8 of this manual and evaluate any workarounds (changing orientation of the piece, etc.).

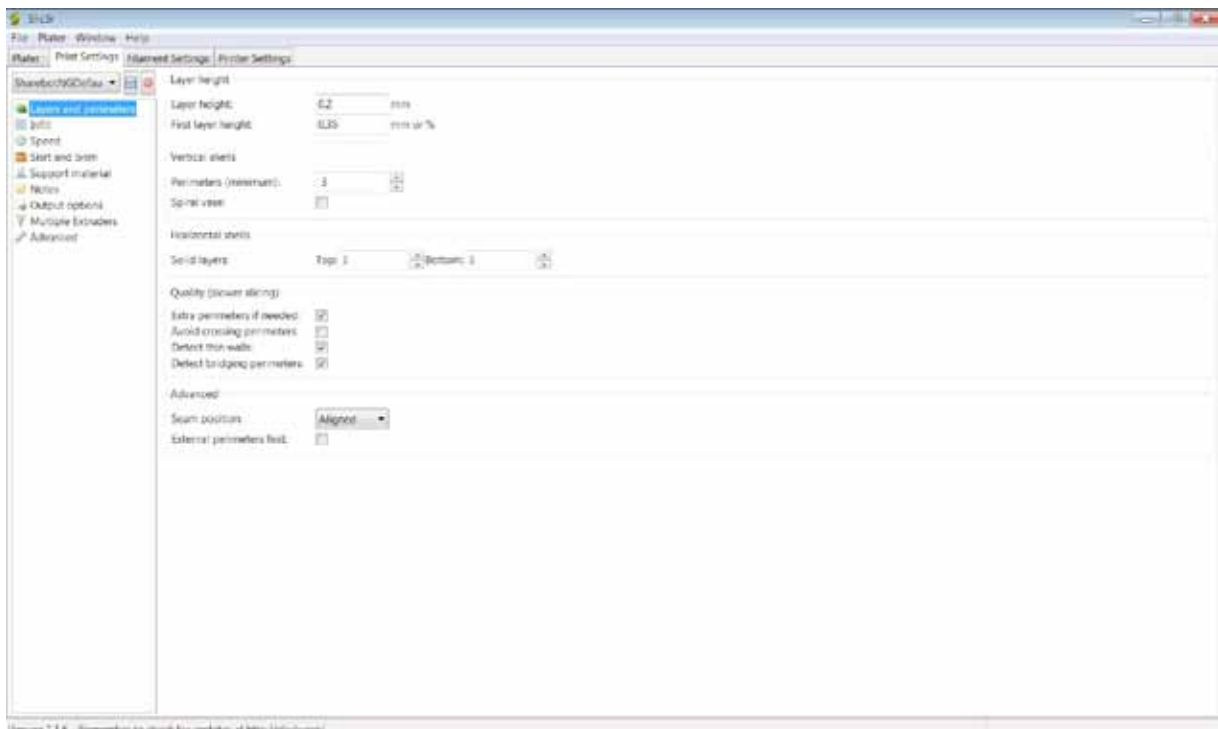

## Slicing

Modified the parameters of our interest we can launch the slicing. Back in the tab “Plater” and click on “export g-code”. Select the destination and name of the file will start the process that, depending on

the complexity of the model and parameters set, it may take up to several minutes.  
The slicing, copy the g-code on the SD Card and we are ready for printing.

### Materials and printing plate

One of the most critical elements in current 3D printers is the superficial treatment of the printing plate. When you extrude the filament, the first layer is crushed by the brass tip on the surface of the plate; if the contact surface is able to create a good bond with the molten plastic can continue printing with solid bases. If cooling the plastic loses adhesion, it is very likely that the press can be damaged due to the departure from the printing plate before the object is completed. There is no single solution for all types of printed filament. For this we mainly see how act the two materials mostly used: PLA and ABS, to which we may link and compare the behavior of other materials.

#### How ABS entails

It is a thermoplastic with characteristics that can be varied by changing the relationship between the three main components (acrylonitrile, Butadiene and styrene) to obtain a material with more flexibility or strength, melting point higher or lower and even other physical parameters such as the percentage of thermal retraction. With ABS are manufactured by injection moulding and several parts of common objects and also the first RepRap 3D printers are printing smart engineering parts and ABS gears. Resists high temperatures before soften and then losing its mechanical resistance and dimensional stability, but as defect has a temperature higher, printing of 230 or more degrees Celsius and during cooling is reduced appreciably, leading often to deformation of the first printed layers and the consequent detachment from the printing plate. To avoid this phenomenon, there are two ways to use so combined. The first way is to have a plate covered with a material that has strong adhesion with the ABS, while the second is to keep the heat (between 60 and 90 degrees) to allow the printer to build the entire piece without thermal retraction occurs so pronounced.

A piece kept in shape with these two steps throughout the press, will be far more dimensionally conforming to 3D model of departure. Often, however, it happens that there is a partial detachment on thin parts and elongated, with significant coverage. In these cases, the printing is completed, but deformed in part to the arching wider print plate in the opposite direction.

The material which at the moment is very handy for keeping the ABS attached to the printing plate is the hairspray: its water-soluble components allow you to create a veil that adheres well to glass dish and at the same time blends and binds with the ABS, keeping it firmly stuck to the glass. To print over, if with the blade of the utility knife or spatula you can't remove the piece (a demonstration of good grip of ABS on lacquer), you can remove the glass tray from the printer and put it under water to soften the lacquer until the piece will come off with ease.

## How PLA entails

This material, created by processing the pulp plant waste rich in cellulose, comes from many preferred over to ABS, although most subject to high temperatures (over 60° tends to become slack). Printing between 195 and 230 degrees, depending on the additives that have been added to color it and modify its physical and mechanical properties. In relation to ABS is more environmentally friendly and does not emit almost no smell when printing. Even the surface of the pieces printed with the PLA is more brilliant and lucida in terms of retirement we have a variation much less accentuated thanks to the lower extrusion temperature. Unfortunately, the range of temperatures in which the PLA remains elastic is wide: so if the piece in print is not properly cooled, threatens to buckle under its own weight or being dragged from the extruder more subtle points.

For optimal adhesion of PLA, lacchiamo to the glass with the lacquer printer in the box provided, and launch printing. For items with a significant basis you should use the riscaldato dish at 50°.

## How other materials entail

The behavior of other materials is due to the PLA and ABS.

Let's see how:

Material	Attributable ABS	Attributable PLA	Tips
HIPS	Extrusion temperature: 235° Plate temperature 90°		Fan Off
Smart ABS	Extrusion temperature : 260° Plate temperature: 90°		Fan Off
Nylon	Extrusion Temperature 240°-265° Plate Temperature: 90°		Printable perfectly on garolite phenolics.
PET		Extrusion temperature 220°-230° Plate temperature 60°	Fan at 100%
Thermosense		Extrusion temperature 210°-220° Plate temperature 50°	Fan at 100%
Cristal Flex		Extrusion temperature 220°-240° Plate temperature 60°	Fan at 100%
PLA Flex		Extrusion temperature 230°-240° Plate temperature 90°	Fan at 100%
TPU		Extrusion temperature: 240° Not Heated Plate	Fan at 50%

**Heated printing plate**

This is an option that allows you to improve the tightness of pieces on the printing plate thanks to flat heating to temperatures at which the ABS still has a certain plasticity and hasn't undergone a deformation due to cool at room temperature. If you intend to print important parts in ABS this option is not only advisable but imperative.

## Chapter 8

---

### Consideration about models orientations

The possibilities offered by your Sharebot NG are very broad, but like all technological tools, this must be understood and used by applying various measures over time more and more sophisticated. If on the one hand, as 3D printer technology, promises to create any shape but are frequent cases where a print ends with a big disappointment.

#### Orientation

Let's start with a consideration on guidance of the pieces in relation to the printing: mechanism of object creation is in layers and each layer is created that it overlaps the previous one. When a wall or a surface is tilted more than 45 degrees, or some parts have not beneath them earlier layers (based in vacuum), it has to do with a certain specific measures requesting model. The first question concerns the possibility to rotate the model with respect to print plan to improve or resolve the issue of inclinations.

Spins may be needed by 90 or 180 degrees, thus changing the portion resting on the press plane. In general, if you can find an orientation that allows a reasonable flat surface extension to be in contact with the press, you are ensuring the tightness of the object to the plate during the printing process.

Let's take the example of a door: printed in its natural position (vertical) would have a thin backing, as opposed to lying down would potentially a lot more contact surface wide and stable. May be details (such as the handle, for example) that don't allow the support: in this case we recommend you remove the handle to print it separately, attaching it with a little glue in its original position. An excellent example of how the orientation can make a printable object without any problems (or, as we shall see, adding media) can be found at <http://www.thingiverse.com/thing:37978>.

It is a house-shaped lamp.

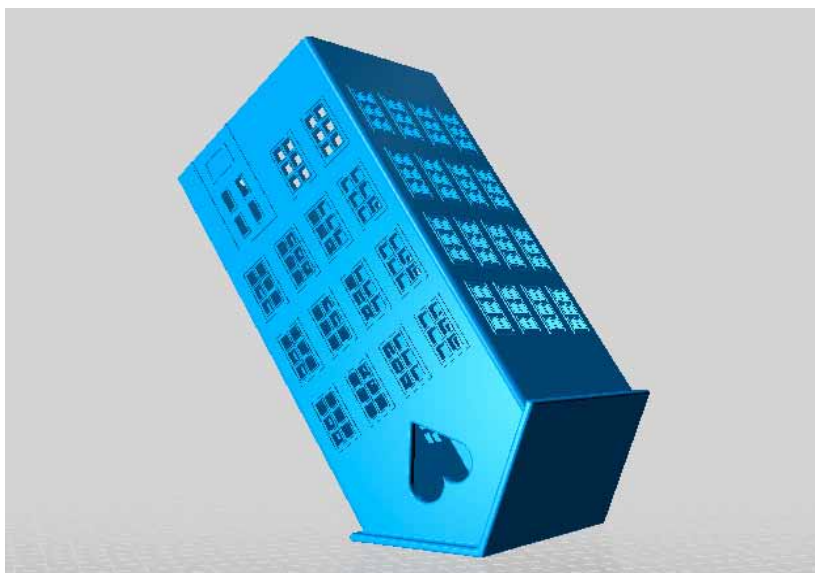

### **Just one object?**

There are cases when printing in one piece is inevitable, but there are as many cases where you can cut into several parts the object to print more easily. An example that you often see on the internet is that the Eiffel Tower: for his height would print a whole small object and with details too tiny to be created from most printers FDM. Cutting the model into two or three parts it is possible to place it in print volume of almost all printers and metal structures large enough to be printed accurately. After the parts can easily be combined with a drop of glue having so perfectly printed Tower and defined.

### **Supports**

When you cannot avoid parties suspended, tilted geese begin in anything you have to give the printer a support on which to begin to create these pieces. The supports are the solution that has developed technology to overcome the force of gravity and allow the creation of complex models, also suspended parts and other parts (balls of a bearing), or with items that necessarily begin (moving upwards) from nothing, as the arms do not place the hips in a bust.

In any case, the problem can only be linked to one detail and then you can create in the model solution. Take the case of this famous model who, thanks to an enterprising user, was modified with the addition of only support necessary to achieve a flawless printing: the lower part of the chin started with some ring in anything, so I added a calculated support to the tenth of a millimeter.

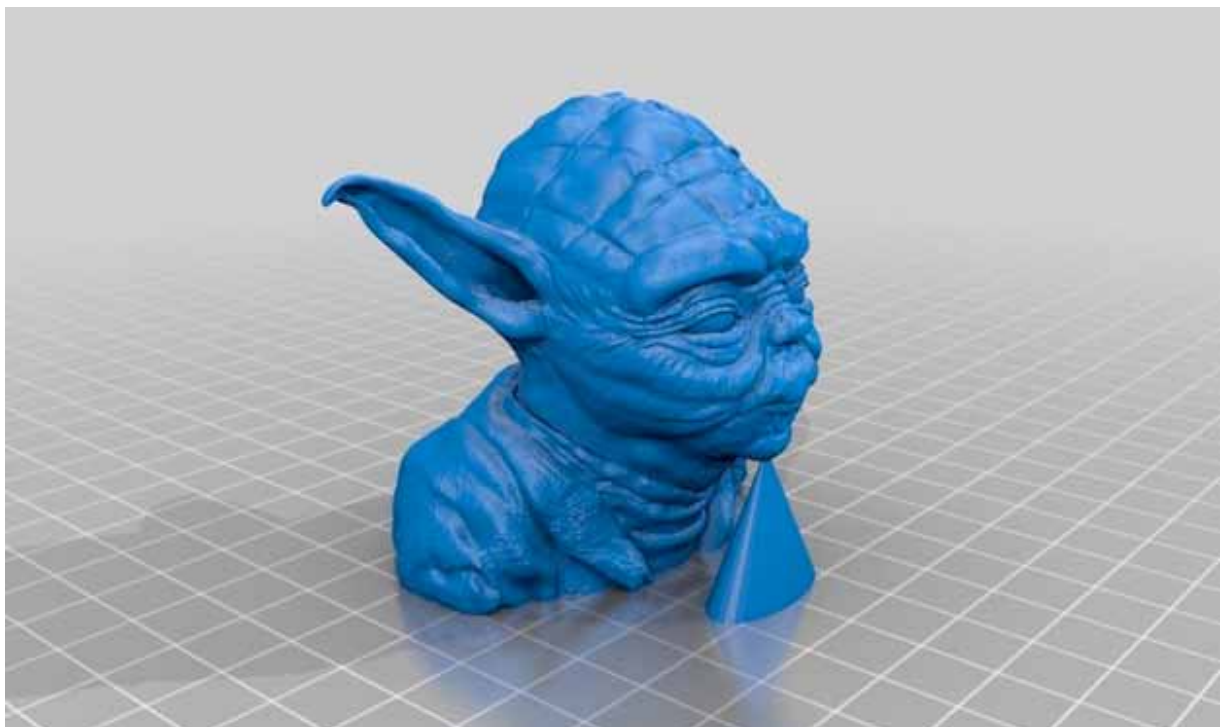

In this way, by printing to be done with some attention and with a critical point, became a print from the result guaranteed.

The supports are still generated by slicing software if it is enabled the creation of print parameters.

Depending on the parameters and the shape of the model, and then create support structures read, so having a filament support. At the end of printing, with some patience, you remove these structures and the piece remains clean and with the shapes you want. Here is an example of an object that requires the supports accompanied by the G-Code generated with these supports

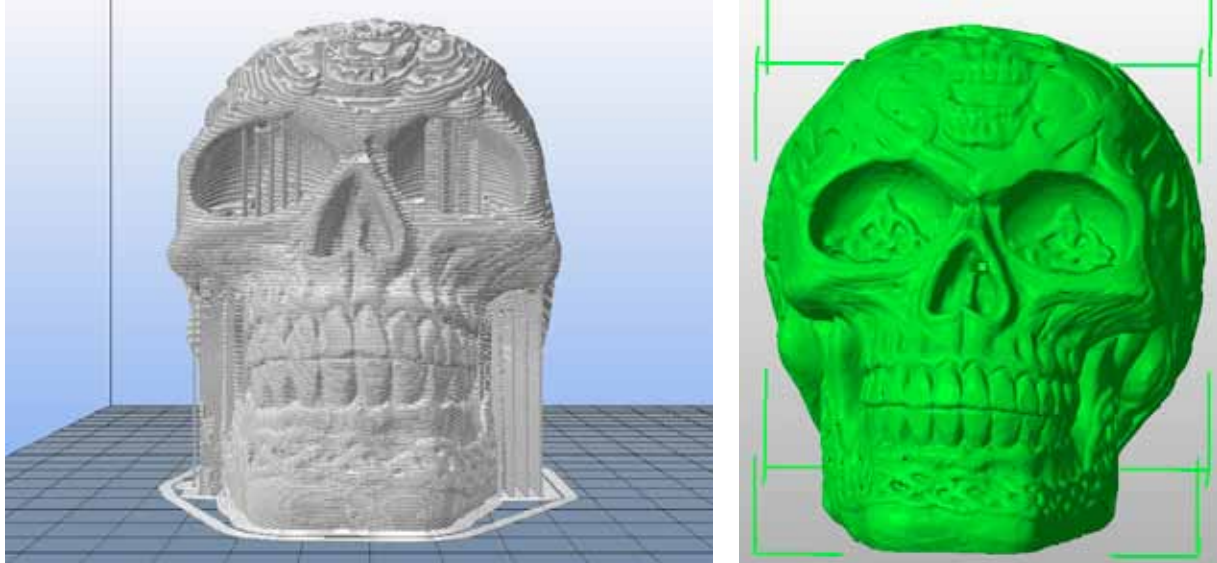

The supports are vertical structures under the cheekbones and inside of the orbits.

Keep in mind that the surfaces of contact between support and model we will have a very low surface finish for the concrete possibility that the two areas are merged together: this will require a finishing to remove the backing material and arrange some finishes (if deemed necessary).

In professional printers supports are manufactured using special thermoplastic, possible to dissolve through special chemical or thermal baths, filed with a second extruder. Even with Sharebot NG, dual-extruder version, you can use as supporting material of the “Poly” (polystyrene) limomene soluble in combination ABS for printing.

### Printing Details

When you print a piece, you define the various parameters including the thickness of the layer. This value has a significant impact on the definition of the object for all surfaces that grow upward with an inclination much bland. Immaginate an inclined plane and mentally slice it: the size of the slices can vary a lot and, if they are drawn with a fixed-width line, you can open the spaces between one layer and the next. If the number of slices increases because they are thinner, the spaces between a and the next layer is reduced so the shape is better defined under the horizontal profile, both in the vertical one. For this reason also the z-axis resolution is hyped as a distinctive element of 3D printers. A side effect of layer thickness prints motto bass (from 0.1 to 0.2 mm) is increasing the printing time: the track will be built with the same amount of material, but the extruder will have take much more “Street” because of the greater number of layers to be created, even if each is made with less material, and then the total does not change.



Each type of object has its own range of optimum thickness for printing and only with a bit of experience you can intervene on this knowing what parameter are you going to actually meeting. Our tip is to choose a small enough, but with an articulated form, upon which to pursue a systematic experimentation, thanks to which you will be able to see the effect of each variation.

The definition on the two axes X and Y it is not controllable by the user resulting from the model geometry, being composed of triangles, could show the facets in place of soft surfaces, rounded or well-detailed. This depends on the number of triangles in the mesh of the components. More triangles can bring greater detail, or are simply the consequence of a process of creating non-optimized mesh. The number of triangles determines a greater job for the slicing software and if the triangles are tens of thousands, then they can even cause processing problems. As you can guess, below a certain threshold the details are no longer “resolved” from the printer and then are basically useless. Or, rather, are significant in view of the enlargement of the model for printing a detail. To reduce the number of triangles describing the 3D model there are several programs and even Slic3r himself provides an option that allows you to define under which size details go ignored, simplifying and speeding up the model slicing.

It should be also considered that the minimum thickness of the walls is recommended for vertical 1.05 mm consisting of three accomplished perimeters of the extruder.

### Double extruders

Printing with two extruders poses no particular difficulty if the calibrations of extruders physical and software were made correctly. Here are all the steps to get the perfect setup. We are assuming that your print plan is aligned properly with a single extruder, extruder detached from left to right and positioned on the left-hand side, in contact with the magnet of parking. The distance of the plane from the tip must be virtually nothing, but without the tip rests: we use a ticket on thermal paper (bit thinner paper that you can easily find) to verify that in the various places you can slide the piece of paper with a minimum of resistance, but without blocks or that course too easy (for further discussion see Chapter 4). When you want to print an object to color, you should double from a file appropriately prepared for this operation as described in the manual of Slic3r. After you import the xxxxxxxx.amf file in the slic3r, select the SharebotDualstrusion.ini printer profiles to correctly create a G-code file.

### Central clamp

Now you can reconnect the two extruders using the central clamp with the two allen head bolts. Do not tighten them and screw them place the extruder torque in a central area of printing. Always use a piece of thin card, ensure that the extruder is still aligned right, then explored the left figuring if ranked, lowest or higher. If aligned, tighten the two bolts carefully avoiding the bracket involves displacements in the alignment. If the tips are not jog, you can use the same to raise or lower the two ends by imposing a slight rotation to both extruders from the bracket and tightening the screws to hold the position. Remember to tighten with a certain decision both bolts as the vibrations may in time result in loss of any realignment obtained with this system. At the factory your Sharebot was however checked and calibrated relative to alignment, but if you have disconnected the extruders or loose central bracket bolts, you must perform the above operation for each “combination” of extruders. If in spite of the measures listed above are required a further correction to bring the same vertical level the second extruder, you can adjust the adjustment screws placed on the two external sides of carts with caution. A good technique is to invoke an auto-home of the printer, make the menu “move axis” the truck centre plate extruder press and by turning the adjustment screws 2 on each basket align the lower extruder to the highest one. At this point if necessary you can re-adjust the printing plate by acting solely on rear dial that serves as the end stroke, z-axis to move it closer to or further from the extruders (see Chapter 4).

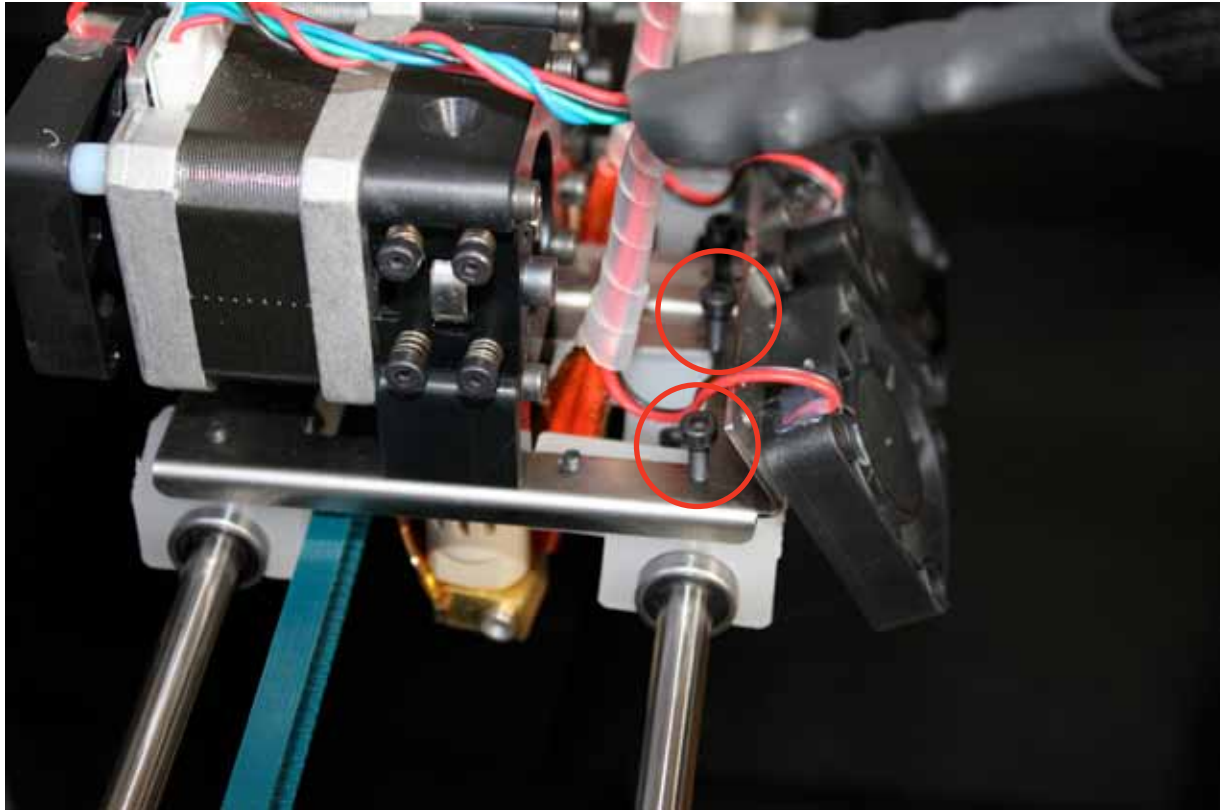

## Offsets

Two extruders printing toggles either to press extruder based on G-Code T0 (0 tool) and T1. When the firmware meets T0, using the main extruder (the right one), and when she meets T1 passes control to the left of the extruder motor. Basically, apart from steering gear of the motor either extruder, firmware continues to move the two print heads with the only trick to add an OFFSET to the coordinates of the G-Code to overlay exactly the point of the original coordinates T1 extruder. The value of the offset is therefore crucial to have a perfectly aligned on the two extruded filaments. Normally this value hovers around -58.5 mm for X and Y to 0, but it can happen that we should make some readjustment. To do this we need a file first to enable us to alternate the two extruders on a design that easily allows you to recognize the misalignment. In our site you can find the SM\_Test\_Bicolor\_NG file.Gcode that has been developed exactly for this purpose.By opening the file with a text editor you can edit the first few lines of the file (around line 25), the value written thereupon M218, increasing or decreasing it according to your needs. The syntax for the F-series is M218 T1 X 35.5-Y0 while the S series is M218 T1 X 58.5-Y0. Start printing with the current values and see how the first layer is made: we start with the perimeters that are alternated between the two extruders, so there is a large part of the border first, followed by the extruder with fill the second extruder. First carefully observed four: perimeters are alternated correctly? Are offset only on an axis? Found the correct offset value, you can enter it in the start g-code of your slic3r ShareBotDualstrusion's profile.

## Refining axes X and Y

If there is staggering on a single axis, you must act on its value (M218 T1 X-*nn*, n Y0 that were found at the beginning of the G-code SM\_Test\_Bicolor\_NG.Gcode), remembering that if you increase the negative value, you move the extruder more right (x) or more inside (y). Well stop printing the first layer until you have obtained a perfect centring eye. At this point let go and watch how you walk away from a solid surface on the first two layers in a thin layer on a particular form that quickly grows. To 5 mm of height is the first extruder and change if the horizontal alignment between the two extruders and correct, there should be no problem of interface between the two colors. The offset that you set should be such as to overlap exactly the two colors allowing the subtle “wall” grow vertically without oscillations from one side or the other. Touch up to the tenth of a millimetre the values if you notice an overlap imperfecta without worrying about whether a “dirty” extruder printing passing above the model: the important thing is the alignment between the two colors on the vertical axis in both directions.

## Modifying the profile with Slic3r

When you have found the ideal values, take note and then plug in the code that is in Slic3r as “custom g-code” in the printer profile ShareBotDualstrusion; in this way you will have your value entered in automatically each print is made with double profile extruder. In this way you’ll also insert the M218 command at the beginning of the G-Code, making it easy to any adjustment due to some readjustment operation of your mechanical (e.g. for combined and separated repeatedly for extruders).

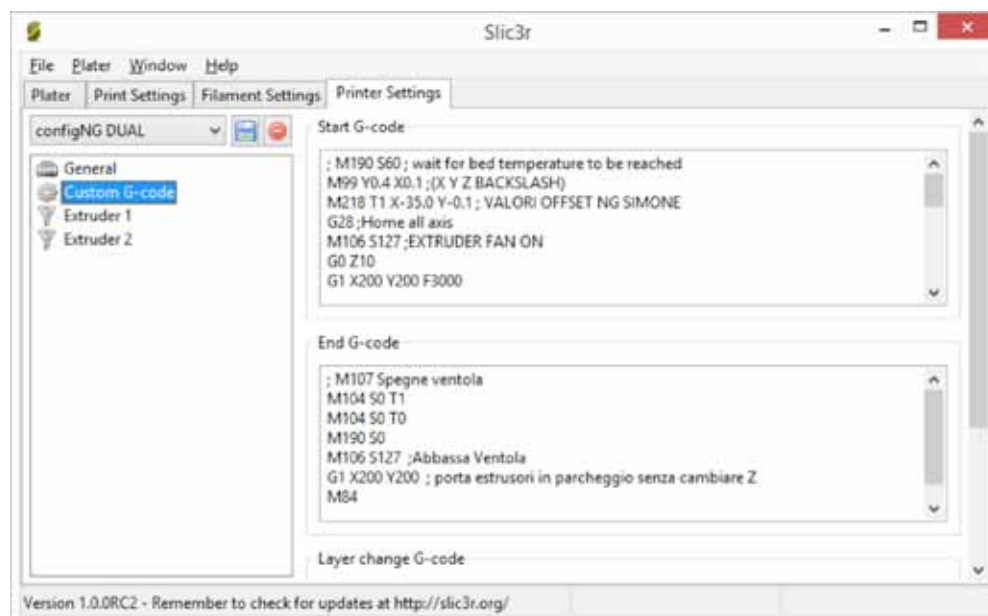

## Positioning the locking printing bed rubber bands

The correct position of the rubber bands for glass block printing plate, in a way that does not interfere with the prints in both single and double extruder is shown in the drawing below. the position of the pegs is not binding or final: pegs in blocking the glass invade useful print area, you can then

change the position based on which in turn will be printed, so as not to find the clamp on the nozzle.

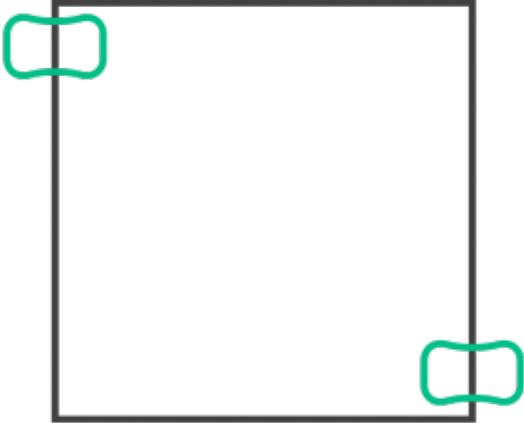

### Ordinary Manutention

#### Cleaning the printer

Sharebot NG does not require any special maintenance, but, like all machinery, efficiency increases if kept clean.

#### Printing bed

The first layer of the object we print is essential to the success of the press: for this reason the printing floor must be perfectly smooth, with a uniform layer of lacquer applied. After many prints, lacquer layers overlap and together with residues of printed pieces are compromising the flatness of the surface of the glass, creating irregularities: taking great care in moving we can wash the glass with warm water and remove any residual impurities.

#### Stretcher

The cogwheel of the motor of the extruder and its cushioned pulley tend to “eat” the filaments. For a perfect sliding filament it is necessary to check if there’s accumulate dust or other debris by stranded on the pulley and onto the sprocket. If you want to carry out thorough cleaning, unscrew the 4 lateral screws (those with springs) and sweep away plaque with its bearing; then removing any residue. After that you can reinstall everything and run the filament.

#### Nozzle

If you want to remove material left on the tip of the nozzle, prepare menu choose “Preheat” left or right depending on the nozzle you want cleaned; then select “move axis”, and then extrude any inch of material from the nozzle until it drags the leftover material earlier. Now select “cools” and when the temperature of the nozzle will be between 100-150° head with tweezers to pick up the dribble of material that hangs from the extruder and pull it off. Alternatively you can select from the menu “Prepare” the exchange command wire to the extruder interested.

#### Lubrification

It is required only after an intensive use of the machine (or early if used in a dusty environment - strongly discouraged! -). In any case it is the machine itself to ask this question began to whistle during handling. Apply a drop of sewing machine oil or a petroleum jelly on top of worm Z and X and Y guides; handled axes to apply uniform oil on total length.

#### Putting in tension the belts

For perfect efficiency of the machine, the belts that move the axes should always be properly coil; to

tighten the straps on the y-axis, we can adjust the screws placed on the top of the shoulders: side for clockwise will increase the tension and vice versa; to tension the belt of y-axis movement we need to adjust the two screws on the right side of the unit fastening the engine y: first must be loosened in order to then move down the engine by increasing belt tension; got the perfect tension tighten the two screws firmly. to tighten the belt for the x-axis the procedure is similar: let us relieve the stepper X screws (on the right shoulder of the machine), move the engine to get the belt and tension and tighten the two allen screws.

### **A correct ventilation**

Your NG is equipped with a cooling fan devoted to electronics, located at the lower left on the front seat: you will notice that when the printer is turned on and stays on at all times. It should make sure that dust or other debris do not obstruct the forced cooling of electronics, blocking in the long run also the functioning of the fan.

The stepper motor of extruder is a fan dedicated to its cooling: it too is vital to the correct managed prints and drawings; If not properly cooled the engine transmits the heat to drag wire wheel, which in turn heating the filament loses efficiency.

The fan motor cooling of extruders must always be pressed when the machine is in motion.

### **Updating the firmware**

Sharebot NG uses an Open firmware and receives frequent updates. We advise you to periodically check our website for updated firmware, so to keep your Sharebot NG optimal operating conditions and potentially improved over previous versions. Instructions on how to do the update are provided along with the firmware. If your printer is doing strange movements you don't want, or do not correspond to the cycles described in the manual, contact our support service describing the problem, it might requires an update to the latest firmware.

### **General information about security**

*Name of the producer:* SHAREBOT S.R.L.

*Address:* via Montello 18  
23895, Nibionno, (LC), ITALY

*Phone:* (+39) 031 692132

*Fax:* (+39) 031 2281412

*Sito web:* [www.sharebot.it](http://www.sharebot.it)



## 1 | General information

### 1.1 Personal details

This use and maintenance manual is an integral part of the SHAREBOT NG (identified in this document, the term machine) realized by the firm Sharebot srl; for this reason, it must follow the machine itself if it is transferred to a new user or owner.

This manual must be stored carefully and protected from any agent that might damage it, throughout the life cycle of the machine.

This manual has been compiled to provide the essential information and instructions to operate properly and safely

ATTENTION: having to be easy and immediate consultation, this manual must be placed in a location known and accessible.

This manual contains all the information necessary to carry out preliminary training necessary to correctly handle the machine; for this purpose must be used.

While showing all the attention and the instructions for the correct use of the machine by the operators or to allow maintenance personnel to intervene correctly, this manual assumes that, in environments where the machine is installed, the existing rules are observed regarding safety and occupational hygiene and staff responsible for operation and maintenance has a degree of education that allows you to interpret the information.

NOTE: the user may request a copy of this document (for example, in case of damage of the original document) by written request to the technical office support@sharebot.it

### 1.2 Ownership of information

The manufacturer declares that the information contained in this manual are congruent with the technical specifications and safety devices of the machine which the manual refers. Drawings, diagrams and technical data are updated to the date of publication of this document and are valid only for the machine to which they were attached.

The manufacturer reserves the right to make changes or improvements without notice to this documentary material.

The manufacturer assumes no liability for direct or indirect damage to people, things or animals arising from the use of this document or material of the machine in conditions other than those laid down.

### 1.3 Content of the use and maintenance manual

This use and maintenance manual is intended for users to understand and properly use the machine.

This manual, in fact, has at its core, as well as a functional description of the machine and its main parts, instructions and directions for:

- carry and successfully install the machine;
- use the machine;
- maintain correct cleaning, maintenance and adjustment of the machine;
- pay attention to the most basic rules of safety and accident prevention.

The user will give way to know both the potential of the machine and the problems that may arise in its management.

You must read the entire manual carefully to understand the instructions and safe operation of the machine;

### 1.4 Definitions and Conventions

#### 1.4.1 General information

The entire documentation for the machine was created by developing the themes indicated by the Machinery Directive (2006/42/CE) and the safety regulations in force; Therefore, it is essential to complete all reading material to get the best performance from the machine and ensure maximum duration of all organs.

#### 1.4.2 Terminology Conventions

MACHINE: is the term used in this use and maintenance manual to indicate the SHAREBOT NG.

dpi: stands for indicating the device (s) personal protective equipment.

#### 1.4.3 Definitions

DANGER ZONE: Any area in the vicinity of the machine in which the presence of an exposed person constitutes a risk to the safety and health of the person himself.

USER: Any person (entrepreneur/business) who uses the machine or who entrusts the use or operations related to people prepared.

EXPOSED PERSON: Any person wholly or partially in a danger zone or near these areas.

#### 1.4.4 Personal means of protection and rules of conduct

For each of the operations described in this manual are given protection means that the user is obliged to use and the rules of conduct to safeguard the safety of users themselves.

#### 1.4.5 Machine status

The status of the machine is the characteristic that describes both the mode of operation (for example, vehicle shutdown) as well as the status of these securities (for example, including guards, guards excluded, isolated from the power supply).

## 2 | Safety and technical data

### General information on safety

#### 2.1.1 Design criteria

For the design of the machine were adopted the principles and concepts introduced by the relevant paragraphs of the harmonized standards listed in table 1.

*Table 1 – main harmonised standards used in the design*

Legislation: UNI EN ISO 12100: 2010 Title: Safety of machinery - General principles for design - Risk assessment and risk reduction

Legislation: UNI EN 953: 2009 Title: Safety of machinery - Guards - General requirements for the design and construction of fixed and movable guards

Legislation: CEI EN 60204-1: 2006 Title: Safety of machinery - Electrical equipment of machines – Part 1: General rules

Compliance with the relevant paragraphs of the abovementioned harmonized standards has made it possible to eliminate or reduce risks as best as possible, both during normal operation and during maintenance and adjustment throughout the life cycle of the machine.

The equipment used was chosen carefully among those available on the market and the materials making up the machine (and the accessories) to be free from risks to health and the health of their people. All parts supplied by third parties are marked CE (when applicable) and conform to the relevant reference directives. All details were strictly controlled in accordance with the standards prescribed by the regulations.

For the machine were adopted, moreover, warning measures and necessary protection against risks.

### 2.2 Devices and Security Solutions

For machinery were adopted devices and constructive solutions described below.

Fixed guards to protect the transmission of motion and part mobile bodies.

Safety signs of danger and prohibition at fixed shelters and the risks present.

### 2.3 Warnings regarding risks

In order to avoid any dangerous conditions for persons or damage to the machine caused by residual risks, namely those risks remain despite all the measures taken, or to be potential risks not evident, the manufacturer advises users of the machine follow the instructions indicated in the following pages.

Warning: always adhere to the warnings and indications of labels applied to the machine and operate exclusively in accordance with the instructions given in this manual.

#### 2.3.1 Lifting and transporting

##### 2.3.1.1 RISKS PRESENT DURING LIFTING AND TRANSPORTING

During lifting and transport there are risks related to:

- operations on the machine by unqualified, untrained, uninformed, untrained or improperly fitted;
- crushing limbs of operators handling personnel;
- projection of moving parts of the machine non-removable or not fitted properly;
- impact or fall by machine components, damaging the machine itself and its protections.

##### 2.3.1.2 PERSONAL PROTECTIVE EQUIPMENT REQUIRED



### 2.3.1.3 ATTENTIONS TO FOLLOW DURING LIFTING AND TRANSPORTING

During lifting and transport it is necessary to follow the precautions described in this paragraph.

- Check and if necessary so that all parties can move are correctly attached.
- Do not lift, for any reason, the various parts of the machine by grasping them for non-structural elements (e.g., cables and casings).

## 2.3.2 Installation and connections

### 2.3.2.1 RISKS PRESENT DURING INSTALLATION AND CONNECTION

During connection setup and there are risks associated with:

- operations on the machine by unqualified personnel, uninformed, untrained or improperly fitted;
- contact with live elements;
- damage of the machine during installation and connection.

### 2.3.2.2 PERSONAL PROTECTIVE EQUIPMENT REQUIRED



### 2.3.2.3 SIGNS PRESENT

The machine is equipped with special reports of danger and prohibition;

### 2.3.2.4 ATTENTIONS TO FOLLOW DURING INSTALLATION AND CONNECTION

During installation and connection is necessary to follow the precautions described in this paragraph.

- Use auxiliary equipment and any other machinery or equipment (electric or pneumatic) only after you understand the instructions in its use and maintenance manuals or after a specific training and formalized.
- Choose installation location:
  - provides sufficient space for normal use as well as for the maintenance of the machine, including space for any peripheral equipment,
  - allows to carry out correctly the necessary connections for operating the machine,
  - having the characteristics described in the paragraph concerning the
- Environmental Conditions of the installation, and, in particular, verify that the installation location of the machine is equipped with adequate forced ventilation system (recommended 30 air changes per hour);
- Before proceeding with the first running of the machine make sure that the parts which make up for any physical damage due to bumps, tears or abrasions and that all connections are correct and have been carried out without the possibility of disconnection

## 2.3.3 Use of the machine

### 2.3.3.1 RISKS PRESENT DURING USE OF THE MACHINE

Risks present during use of the machine:

During use of the machine, there are risks associated with:

- use of the machine by unqualified people, not trained, uninformed, untrained or improperly fitted;
- risk of crushing close upper limb moving bodies of engines controlling the movements along three axes, and close to the work surface in the event of sinking;
- danger of projecting components or parts of components, in the case of wrong performance or processing in case of obstruction of the extrusion nozzle;
- danger of inhaling fumes produced by hot extrusion process;
- danger of scalding and burns due to contact with extrusion nozzles, the work plan, the material being deposited on the floor and just settled;
- contact with live parts (due to poor maintenance of the electrical parts);
- danger of direct exposure to artificial optical radiation (LED).

### 2.3.3.2 PERSONAL PROTECTIVE EQUIPMENT REQUIRED



### 2.3.3.3 SIGNS PRESENT

The machine is equipped with special reports of danger and prohibition;

#### 2.3.3.4 ATTENTIONS TO FOLLOW WHILE USING THE MACHINE

During use of the machine it is necessary to follow the precautions described in this paragraph

- Operate the machine only if all devices for protection and safety are integrated.
- Do not remove, for any reason, devices and security guards installed.
- Follow all safety warnings and hazards affixed on the machine.
- Ensure that all reports of danger and safety affixed on the machine are always legible.
- Always check the absence of any other person near the machine before starting any processing or movement thereof.
- Wear all PPE required, regularly check the integrity (reporting immediately the dpi is no longer able to perform the specific task for which they were awarded).
- Not to intervene on the machine without having read carefully and thoroughly this manual.
- Use the machine at a location that has the features described in the paragraph concerning the Environmental Conditions of the installation, and, in particular, verify that the installation location of the machine is equipped with adequate forced ventilation system (recommended 30 air changes per hour) and that this system is turned on and functioning properly.
- Do not touch the nozzles of extrusion, the worktop and the material being deposited on the floor and just deposited during operation of the machine and during the pre-heating phase; always wait until the sufficient time necessary for cooling of the above-mentioned parties.
- Report abnormal operating situations.
- Do not perform any action (including cleaning) at moving parts or hot surfaces.
- Do not attempt to rotate the machine incidents (please refer to the indications given in this manual).
- Do not attempt to stop or slow down the movement of moving parts with your hands, with other parts of the body, tools or objects of any kind; also avoid physical contact with any moving of the machine body.
- Do not look directly into the LED light when turned on.
- Do not use the machine when you are under the influence of drugs or drink that may reduce alertness

#### 2.3.4 Maintenance and Demolition

##### 2.3.4.1 RISKS PRESENT IN MAINTENANCE AND DEMOLITION PHASES

During demolition and maintenance there are risks related to:

- operations on the machine by unqualified, untrained, uninformed, untrained or improperly fitted.
- contact with electrical parts under voltage
- impact and crushing by machine components moved or fixed or remounted incorrectly
- danger of crushing close upper limb moving bodies of engines controlling the movements along three axes, and close to the work surface in the event of sinking;
- danger of projecting components or parts of components, in the event of obstruction of extrusion nozzle;
- danger of inhaling fumes produced by hot extrusion process;
- danger of burns due to contact with extrusion nozzles, the work plan, the newly deposited material.

##### 2.3.4.2 PERSONAL PROTECTIVE EQUIPMENT REQUIRED



##### 2.3.4.3 SIGNS PRESENT

The machine is equipped with special reports of danger and prohibition;

##### 2.3.4.4 ATTENTIONS TO FOLLOW DURING MAINTENANCE AND DEMOLITION

During demolition and maintenance it is necessary to follow the precautions described in this paragraph.

- Perform required operations using standard tools and necessary always wearing PPE
- The execution of maintenance and demolition operations must be carried out by qualified and specially trained.
- Respect the prescribed intervals for maintenance operations.
- Check that the power supply has been appropriately sectioned (plug removed) and that nobody can turn it back on before the end of the interventions required (using appropriate signage).
- Do not attempt to stop or slow down the movement of moving parts with your hands, with other parts of the body, tools or objects of any kind; also avoid physical contact with any moving of the machine body.
- Use auxiliary equipment and any other machinery or equipment (electric or pneumatic) only after you understand the instructions in its use and maintenance manuals or after a specific training and formalized.
- Do not use, for no reason, petrol, solvents or inflammable fluids for cleaning of details, but use commercial cleaners and approved non-combustible and non-toxic.
- Do not touch the nozzles of extrusion, the worktop and the material being deposited on the floor and just deposited during operation of the machine and during the pre-heating phase; always wait until the sufficient time necessary for cooling of the above-mentioned parties.
- Do not tamper with the guards and protection devices of the machine.
- Before operating the machine, make sure that there are no people who are performing maintenance operations which have been restored and all safety de-







vices of the same.

- Before operating the machine, verify that you have restored all of its safety devices.

## 2.4 Recommendations on the safety

On the machine are present the signal plates shown in the table 2.

Table 2 – Description of the plates these reporting

PLAQUE	DESCRIPTION
A 	Plaque CE.
B 	Indicates the danger of electrocution at electrical casings of the machine where it is positioned.
C 	The obligation to wear specific PPE (eyewear) during use of the machine.
D 	Signals the danger due to the presence of moving bodies at the point where the machine is placed.
E 	Points out the danger of crushing at the point where the machine is placed.
F 	Report the presence of hazard hot surfaces at the point where the machine is placed.
G 	The danger for the presence of artificial optical radiation (LED) at the point where the machine is placed.

## 2.5 Indications about noise and vibrations

The machine was designed and constructed in such a way as to minimise the noise level during normal operation, taking account of technical progress and of the ability to have means to limit noise.

In any case, the acoustic pressure emitted by the machine and measured at the workstation provided is less than 70 dB (A).

Under conditions of use in accordance with manufacturer's instructions in this manual, the vibrations are not such as to give rise to dangerous situations.

The operator however, if vibrations occur, must stop the machine immediately and report the problem in writing to the manufacturer's assistance service support@sharebot.it

## 2.6 Proper and improper use of the printer

The machine is designed and created for the purpose of creating prototypes and objects in three dimensions, starting from a technical drawing.

The materials that the machine can work are PLA plastic strands, ABS, ABS plus, Nylon, rubber, Polystyrene, Cristal TPU Flex, PLA sand, PLA wood with a diameter of 1.75 mm.

The machine needs electric power.

The use of the machine to perform operations other than those described above may only be carried out after consulting the SHAREBOT S.R.L. and with the written consent of the same.

The machine has been designed and built to work in environments where there is a potentially explosive atmosphere and by itself cannot generate a potentially explosive atmosphere.

The use of the machine for different transactions may cause damage to persons or to the machine itself and are therefore considered improper for which the manufacturer will not be liable.

ATTENTION: in case of a different intended use is essential to consult in advance with the manufacturer's technical department.

## 2.7. Warnings and general rules of conduct

In order to avoid any risk to people or damage to the machine, it is recommended to carefully follow the instructions and General behavior rules herein.

WARNING: the manufacturer declines all responsibility for damages to things and/or people resulting from improper interventions carried out by unqualified, untrained or unauthorized use.

WARNING: prevent the machine from being used by unauthorized personnel or by personnel not trained without supervision: in fact, before starting work, each user must be perfectly aware of the position and operation of all commands and the characteristics of the machine; must also have read this manual in its entirety.

- Before using the machine make sure that any security-threatening condition was properly deleted and that there are no dangerous areas and operators in the vicinity of the machine.
- Before using the machine, ensure that all guards or other protections are in place and that all safety devices are present and efficient.
- Consult this manual as regards the applicable safety requirements and specific to dpi for personal safety; in particular, however, the machine personnel should wear appropriate clothing, avoiding or paying due attention to:
  - fluttering clothes,
  - wide sleeves,
  - ties or scarves dangling,
  - necklaces, bracelets and rings.
- The work area must never be taken to interfere with the freedom of movement of the user.

WARNING: tampering with or unauthorised replacement of one or more parts of the machine and the use of accessories, utensils, supplies other than those specified by the manufacturer can result in risk of injury.

## 3 | Transport and Installation

### 3.1.1 Environmental Conditions of the installation Site

The machine does not require special environmental conditions for its operation.

The machine must be installed and work in closed rooms protected against atmospheric agents.

CAUTION: make sure in any case that ambient lighting is sufficient to operate safely; If not, you must install one or more light sources appropriately spread

DANGER: the machine installation must be equipped, by the customer, appropriate forced ventilation system (recommended 30 air changes per hour), to avoid inhalation of the fumes produced by the extrusion process.

### MINIMUM SPACE FOR INSTALLATION OF THE MACHINE

The installation at the place of work must be done so that the machine and its equipment are accessible to allow the correct use. For the choice of the place, as a general rule, it is necessary to take care that the user can move freely around the machine.

### 3.2. Transport and handling

The transportation and handling of the machine may occur in the following situations:  
storage of the machine;

- Assembly and installation of the machine;
- Uninstallation and disassembly of the machine;
- Moving and relocation of the machine.

Please refer also to the instructions regarding the residual risks and specific warnings.

To perform the task under consideration requires the following personal protective equipment:



### 3.3. Installation

**WARNING:** the manufacturer declines all responsibility for damages to things and/or people resulting from improper interventions carried out by unqualified, untrained or unauthorized use.

To perform the task under consideration requires the following personal protective equipment:



Please refer also to the instructions regarding the residual risks and specific warnings.

#### 3.3.1 Connection to electricity supply

**WARNING:** make sure that the circuit-breaker/isolator on the printer is in “0” position, i.e. turned off.

**CAUTION:** If the operating voltage is not responding to its demands, it is necessary to apply a transformer.

- Connect the power cable to the printer.
- Connect the power cable to the power socket on the wall.
- The socket-outlet must be installed near the equipment and shall be easily accessible

Additional warnings about the connection to the power supply:

- You need to install a suitable protection differential type upstream of the point of connection of the electric power of the machine, in order to isolate each element in case of faults in the operation; the choice of differential protection device should not be inconsistent with the provisions of the law, with local regulations, with the characteristics of the electrical system of the settlement and of the machine itself.

**WARNING:** the manufacturer declines all responsibility for damages to things and/or people resulting from improper interventions performed by unqualified people, not trained, untrained or not authorized.

### 3.4. Storing

In case you need to keep for a period of time the machine before make install (or uninstall), it is recommended that you protect it properly and store it in a suitable environment, having the following characteristics:

- external surfaces are resistant to atmospheric agents;
- protected against access by unauthorized persons;
- equipped with fixed floor drain water, free from vibrations and passable to vehicles and lifting equipment;
- with the following environmental conditions:
  - good ventilation;
  - room temperature between -20° C and +50° C;
  - relative humidity between 30% and 80%;
  - in dry and dusty atmosphere.

## 4 | Starting and using the machine

**WARNING:** the manufacturer declines all responsibility for damages to things and/or people resulting from improper interventions performed by unqualified people, not trained, untrained or not authorized.

To perform the tasks of commissioning of the machine you will need the following personal protective equipment:



**WARNING:** do not touch the extruder, even while it's warming up, since it reaches temperatures up to 230° c. Similarly, do not touch the building plan that can be heated up to 110° c.

**WARNING:** do not touch the filament of melted material, but wait until it cools down and solidifies.

#### 4.1 Arrest

To stop the machine at any time you need to move the power switch to the 0 position – OFF and then pull the plug to the wall.

## 5 | Manutention and Demolition

To ensure maximum reliability to the machine and prevent hazardous conditions observe the instructions and warnings given on the following pages.

**DANGER:** for security reasons, all maintenance operations given in this chapter should be performed only by qualified and specially trained technicians. The technicians must also have all the tools and PPE necessary to operate safely.

**DANGER:** all cleaning and maintenance work on the machine must be carried out with the power switch to the 0 position – OFF and wall plug disconnected.

**DANGER:** before you intervene on the machine wait for cooling all parts which may reach high temperatures (even 210° C), or the extruder, building plan, the strand of melted material, the material just settled.

All environmental-impact materials that you need to delete after servicing must be disposed of according to the regulations.

In any case, to carry out all the maintenance or cleaning below at the machine, you will need the following personal protective equipment:



Please refer also to the instructions regarding the residual risks and specific warnings in section 3.3.4.

### 5.1 Troubleshooting, diagnosis and maintenance

To solve some problems and maintenance and cleaning tasks for your Desktop 3D printer SHAREBOT NG, visit [www.sharebot.it](http://www.sharebot.it) under “support”>”How to”.

**DANGER:** be careful not to cut yourself in case the plan is of glass, always use gloves.

**NOTE:** for more detailed information about troubleshooting or solve any other problems check the how-to section on the website [www.sharebot.it](http://www.sharebot.it).

Refer to how-to sections of the web site [www.sharebot.it](http://www.sharebot.it) to learn whether text that you will also find videos on channel SHAREBOT on youtube.

Remember that in case of need you can send an email to [support@sharebot.it](mailto:support@sharebot.it) stating exactly your problem.

### 5.2 Extraordinary Maintenance

Each intervention, such as the replacement of components, must be carried out in collaboration with SHAREBOT technicians. Get in touch with SHAREBOT support via email [support@sharebot.it](mailto:support@sharebot.it).

### 5.3 Decommissioning, dismantling and demolition

To perform disassembly and demolition you will need the following personal protective equipment:



For the decommissioning of the machine for a long time, perform the following steps:



1. disconnect the machine and remove the plug in the wall.
2. clean the machine.
3. Perform even routine maintenance operations and cover the machine with a cloth.

If necessary, disassemble and dismantle the machine, perform the steps below.

1. Disconnect the machine and remove the plug in the wall.
2. Disconnect and store the parts in environmental impact, namely:
  1. a. separate the various parts that could cause pollution;
  2. b. make a selection of materials in order to promote recycling, earmarked to differentiated disposal (specifically select items in plastic or rubber).
3. Dispose of carcasses; that is, once the removal and storage of pollutant elements, relying on specialized facilities for the disposal of carcasses.



**SHAREBOT**

Sharebot S.r.l.  
Via Montello, 18  
23895 Nibionno (LC)  
[info@sharebot.it](mailto:info@sharebot.it)