

zortrax

3D Printer User Guide

Inkspire



Table of content

Introduction	3
General Safety Information	3
Learn More About the Zortrax Inkspire	7
How does the Zortrax Inkspire work?	8
What's in the Box	9
Main Components	10
Zortrax 3D Printing Technology Glossary	12
First Use Preparations	15
Connecting the printer to a network	22
Firmware Update	26
Navigating through the Menu	27
Changing the Resin	28
Platform Calibration	33
Z-SUITE Installation	36
Starting, Post-Processing and Removing a Print	37
Available Materials	45
Basic Maintenance and Service Work	46
Support and Troubleshooting	50
Error Messages	51
Specification	54
Recycling	56
Certification	56

Introduction

Read this User Guide carefully and thoroughly before operating the Zortrax Inkspire for the first time. The User Guide includes basic information about the 3D printer, safety and protection guidelines as well as advice on preparing the machine for the first printing process and basic maintenance work. Ignorance and non-compliance with these instructions may result in property damage, injuries, device failures or lower quality of 3D prints. It is also necessary to ensure that every 3D printer user knows, fully understands and follows the instructions provided in this User Guide.

The Manufacturer makes every effort to ensure that Zortrax products are safe in transportation, installation, usage, storage and disposal. However, due to the lack of direct and ad hoc control as well as other conditions influencing the device and those that are beyond the Manufacturer's knowledge, the Manufacturer is not responsible for damage, injuries, failures and costs resulting from improper transportation, installation, usage, storage and disposal.

Furthermore, the users should take into consideration the risk of possible damage of the device resulting from defects in material and workmanship.

The users are responsible for qualifying and determining the intended use of 3D printed models. The Manufacturer takes no responsibility for any use of printed objects, especially when those objects constitute a part of safety devices or strictly regulated by specific rules medical, military or space science equipment.

Due to the size and specificity, the Zortrax Inkspire is not intended for use by minors and by people with reduced manual, motor and psychomotor skills. The Manufacturer recommends providing assistance and guidance to people with disabilities and older adults who wish to operate the printer.

General Safety Information

This User Guide contains important safety directions that should be followed during installation and operation of the Zortrax Inkspire. It also mentions situations which require special attention and includes warnings against negligence and misuse that could cause damage or injuries.

Always read the safety data sheets available at: <https://zortrax.com/resins/>. They are a source of basic information and safety procedures for the materials you bought. It is essential to regularly update the firmware to avoid any kind of failures.

Visit our website: <https://zortrax.com/> to learn about the latest news and updates.

Printing process with the Zortrax Inkspire requires using synthetic resin which in a liquid form is toxic and may cause allergic reactions. Therefore, you must protect your skin and eyes when using the printer by wearing safety gloves and glasses. Provide proper ventilation in the print room.

It is also extremely important to avoid spilling the resin on the printer and its surroundings while operating the printer, filling the tank and removing prints from the platform. Ensure that the printer is level and keep it on a stable surface. Do not remove the UV cover during the printing process.

Do not leave the machine unattended during the printing process - check it periodically for proper functioning in order to avoid potential accidents or breakdowns. Do not ignore warnings and notifications displayed on the screen. Turn off the printer and empty the resin tank once the printing process is finished.

Monitor your device for wear and tear regularly. Contact our Support Center via the support form at: <https://support.zortrax.com/support-form/> for assistance while replacing worn or broken parts.

Keep the printer away from heat sources, flammable materials, equipment emitting radiation, sources of fire, humidity, water and other liquids. To prevent any inadvertent use, keep the device out of reach of children and animals. It is forbidden to drop or shake the printer as it may cause breakdowns. The equipment is not intended for use in a potentially explosive environment.

The Manufacturer strongly recommends setting up a special room dedicated only to 3D printing. The room should be as free of daylight as possible and properly ventilated. It is important to avoid situations in which liquid resin is exposed to daylight.

Workplace Health and Safety

All service and maintenance activities as well as device operation and maintenance require using safety gloves and glasses included in the Starter Kit. It is also advisable to wear protective clothing.

Keep the workplace clean. Containers with resin should be tightly closed and kept in a dark place.

The device should be configured according to its intended purpose. Improper configuration may cause defective operation which may lead to damage of the device.

Food and beverages should be kept away from both the 3D printer and the 3D printed objects. Do not put any objects under the UV cover.

While operating the Zortrax Inkspire, all measures regarding health and safety that are provided in this User Guide as well as in separate regulations should be taken into account.

If the device begins to operate in an unidentified way, safely unplug it from the power source and immediately contact the Manufacturer through the support form at: <http://support.zortrax.com/support-form/>.

Electrical Safety

Zortrax 3D printers have been tested for compliance with Low Voltage Directive. In order to ensure the highest safety standards, including protection against short circuit, overload, overvoltage and printer overheating, do not attempt to modify the printer and do not use electronic replacement parts other than those recommended by the Manufacturer.

Replace electronic units according to the instructions and be particularly careful while using the tools supplied with the printer.

Before plugging the power cable into the outlet, make sure that the power supply voltage in the outlet matches the required value provided on the nameplate at the back of the printer. Avoid overloading the outlet with too many devices.

The printer must be well-grounded. Always make sure that the ground complies with local and national regulations.

Use only the original power cable supplied with the printer. Do not damage, cut or repair the cable. A damaged cable should be immediately replaced with a new one. The cable should be used according to its intended purpose and should be protected from heat, oils, sharp edges and moving components of the device. A damaged cable increases the risk of an electric shock.

Do not expose the device to rain and humidity. While filling the tank with resin, be careful not to spill the resin outside the tank. Liquid that enters the inside of the device increases the risk of an electric shock.

All maintenance and repair work should be carried out while the device is off and unplugged. Modifications such as soldering of electronic subunits are forbidden.

Mechanical Safety

The Zortrax Inkspire has movable components, such as the build platform and the Z-axis. Therefore, it is forbidden to reach into the printer or put anything inside the printer when it is running, about to start running or at rest. This may lead to serious injuries or damage.

Tools and accessories delivered with the printer should be used with special care only for intended purposes. Improper use may cause serious injuries.

While following post-processing procedures, wear safety gloves and glasses to avoid injuries that may be caused by sharp edges and fragile elements of models.

A finished print must be removed from the platform outside the printer, after both the platform and the model have been cleaned from uncured resin in a liquid detergent.

To avoid injuries, be particularly careful while removing prints from the platform. Always wear gloves and glasses.

The FEP film that is installed in the resin tank is very thin and fragile, therefore, special care should be taken when cleaning, installing and disassembling the tank.

Risk of Burns

There is no risk of burns as all components working in high temperatures are enclosed and protected from being touched.

Constructional modifications of the printer's operating temperature are not permitted as it may cause serious injuries or bring damage to the device.

Safe Storage and Transport Guidance

Zortrax devices must be stored between 0 and 35° C [32 - 95° F]. The storage space should be free of moisture and other extreme conditions.

Transport instructions:

When stacking several devices on a pallet, follow the instructions provided on the packaging. Once device may weigh more than 10 kg [22 lb]. It is therefore advisable to provide safe pallet storage but not higher than 1.7 m [5'7"]. It should be noted that the packages must not project beyond the outline of the pallet. Packages stacked on the pallet should be then bound together and wrapped in foil. The pallet prepared as above can be then forwarded to the shipping company.

Pallet stacking and destacking should be carried out by two people. The package with the device should be lifted or moved using special handles.

Electromagnetic Compatibility (EMC)

Zortrax printer complies with Part 15 of the FCC rules. Its operation is subject to the following two conditions: this device may not cause harmful interference, and this device must accept any interference received, including interference that may cause undesired operation.

The printer generates, uses, and can radiate radio frequency energy and, if not installed and used in accordance with the following User Guide, may cause harmful interference to radio communications. Operation of this device in a residential area is likely to cause harmful interference, in which case the user will be required to eliminate the interference at his own expense.

Learn More About the Zortrax Inkspire

Zortrax Inkspire is a 3D printer which, together with Z-SUITE and dedicated materials, constitutes the whole 3D printing ecosystem. This device makes it possible to turn digital, three-dimensional projects into reality using the UV LCD technology which relies on curing liquid photopolymer layer after layer. The UV LCD technology involves projecting an image of a layer on the transparent underside of the tank with liquid resin and curing the layer using backlight from a UV lamp. After each layer is cured, the lamp pauses to operate. During the pause, the layer solidifies and the platform rises and lowers itself so the resin is equally distributed in the tank. The printer is equipped with an LCD screen which is responsible for projecting successive layers and masking the UV light. Thanks to that, the resin that is outside the image of a layer is not cured and can be used to print the rest of the model. The printer allows users to print multiple parts at the same time without affecting the accuracy and printing speed. Once the printing process is finished, the model has to be post-processed in two steps. The first step involves cleaning the print from residues of uncured resin in a liquid detergent, whereas the second step involves additional UV curing so that the object acquires its intended properties. The Zortrax Inkspire can be used for creating prototypes and concept models in engineering, as well as for creative applications, such as figurines and gadgets.

How does the Zortrax Inkspire work?

Everything begins with preparing a model. The work on the project can start in any program which creates 3D models and generates .stl, .obj, .3mf, or .dxf files. These are the standard file formats supported by most types of modeling software - the model is saved as a set of three-dimensional triangles (triangle mesh).

The next step is to open the .stl file (or other) in Z-SUITE - the program created specifically for Zortrax devices. Z-SUITE prepares the model by slicing it into individual layers and saving it as a .zcodex file. Z-SUITE also allows you to choose the material type to be used for the model and to adjust the necessary print settings, such as layer thickness, layer exposure time, exposure off time or how many support structures should be generated. The file is then ready to be printed.

To start the printing process, turn on the printer, prepare the material which corresponds with the one you have chosen in Z-SUITE and carefully fill up the tank with an appropriate amount of liquid resin. While working with the Zortrax Inkspire, you can start, stop and pause the printing process in Z-SUITE. Once your file is prepared, you can transfer it from Z-SUITE to the printer's storage in two ways. You can either save the file on a USB flash drive and plug it into the port at the front of the device or transfer the file from Z-SUITE over Wi-Fi/Ethernet cable. In addition, Z-SUITE allows you to add several printers to the panel and create a network of devices. This solution makes it possible to produce 3D models in a small series and manage the whole process from the screen of your computer. Each printer can still be operated using the touchscreen at the front. It is also possible to change all settings related to exposure time of particular elements of the model directly during the printing process.

What's in the Box

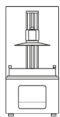

**Zortrax Inkspire
3D Printer**



USB Drive



WIFI Module



UV Resin



Power Cable



**Z-SUITE &
Quick Start Guide**



**Safety Gloves &
Safety Glasses**



Cleaning Box



Spatula



Plastic Spatula



Plastic Wrench



Allen Keys



Screwdriver



Pliers



Cutting Knife



Adhesive Piece



Funnel



Silicone Funnel



FEP Film



**Additional
Screws**

Main Components

1. Left-side view

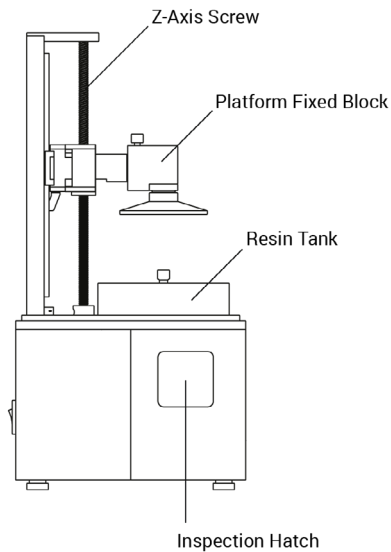

2. Back view

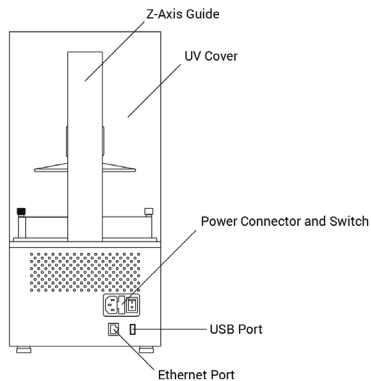

3. Right-side view

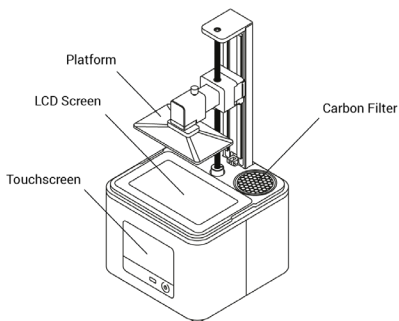

Zortrax 3D Printing Technology Glossary

CARBON FILTER

a filter which absorbs unpleasant smells from the air that passes through the printing chamber. It is installed in the back right corner of the printer's housing. In order to ensure proper filtration during the printing process, the filter should be replaced every 3-4 months, or once it becomes considerably dirty, e.g. with liquid resin.

FIRMWARE

the software programmed into Zortrax printers, which controls and monitors all the data in the device. It also gives the possibility to enable/disable the printer's functions.

FEP FILM

the double-layered, transparent foil which is installed in the rack attached to the resin tank. It creates a clean way for the UV light to quickly and precisely cure liquid resin during the whole printing process. The FEP film requires replacement once it becomes stretched or deformed. The printer is delivered with a set of four FEP films.

LCD SCREEN

the flat-panel display essential for 3D printing in the UV LCD technology. It is responsible for projecting images of layers on the underside of the resin tank during the whole printing process. It also masks the UV light so that the resin that is outside the image of a layer is not cured and can be used to print the rest of the model.

PLATFORM

an integral part of the printer, to which models adhere during the polymerization of resin. Also, it rises and lowers itself during the printing process so that each layer can solidify and the resin can be equally distributed in the tank. The platform is made of anodized aluminum which facilitates high adhesion of models. It can easily be removed or installed back in place.

RAFT

the first few layers of resin which begin the whole printing process. These layers are always printed before the main object and have a larger area than that object. Once the printing is done, the raft needs to be removed from the platform together with the rest of the model. The raft increases adhesion of the print and support structures to the platform.

RESIN TANK

the container in which liquid resin is kept throughout the entire printing process. It consists of a metal frame and a rack with a double-layered FEP film. The resin tank is secured to the printer's housing directly on the LCD screen with two screws.

STARTER KIT

several pieces of equipment that are put together in one set and delivered with the printer. The set contains tools and protective equipment including, for example, FEP films, funnels and spatulas. The tools from the starter kit are required for operating the printer as well as for performing maintenance work.

SUPPORT STRUCTURES

special 3D printed structures in the form of pillars which ensure that the whole model adheres to the platform and doesn't fall into the resin tank during the printing process. Supports are printed with the same material as the model. Once the printing is done, supports have to be removed from the model by hand or using pliers.

TOUCHSCREEN

the display screen placed at the front of the printer, which enables fast and intuitive navigation through the device's menu. The screen also displays information about the current printing process and other information concerning the printer.

ULTRASONIC CLEANER

a device which cleans printed objects from liquid resin remains. This process also helps to avoid streaks that can appear on the surface of models after curing in UV light. The Ultrasonic Cleaner uses high frequency sound waves and liquid detergent. Cleaning time depends on the size of the model, but it shouldn't exceed three minutes. Longer cleaning time causes the liquid to heat up.

UV COVER

the orange cover placed on top of the printer responsible for protecting liquid resin from ambient UV light. It also helps to keep unpleasant smells of resin inside the printing chamber.

UV LCD TECHNOLOGY

a technology which relies on curing photopolymers layer after layer. The UV LCD technology involves projecting images of successive layers on the underside of the tank with liquid resin and curing them using backlight from a UV lamp.

ZCODEX

a file format which contains a model prepared for 3D printing with previously selected print settings, such as layer exposure time, exposure off time, additional support exposure time, etc. All print settings can be managed in Z-SUITE before generating the .zcodex, but it is still possible to change some of the settings during the printing process using options from the menu. Each .zcodex file can be transferred to the printer directly from Z-SUITE over Wi-Fi/Ethernet cable or using a USB flash drive.

Z-SUITE

the application created specially for Zortrax devices. Z-SUITE prepares a model for 3D printing by generating the file in the .zcodex format. Z-SUITE allows the users to change and adjust the print settings, such as the size of the model, layer thickness, or how many support structures will be generated. The last step is to transfer the file to the printer's storage over Wi-Fi/Ethernet cable or by using a USB flash drive.

First Use Preparations

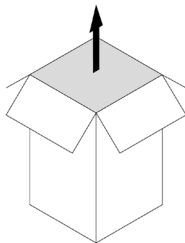

1. Open the box and remove the upper cushioning.

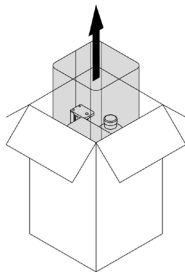

2. Remove the UV cover.

zortrax

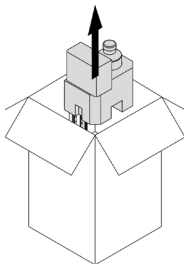

3. Remove the Starter Kit and the foam with the bottle of resin.

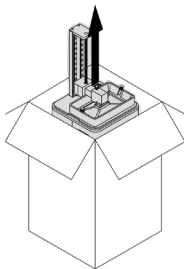

4. Take the printer out of the box. Do not grab the Z-axis screw when lifting the printer.

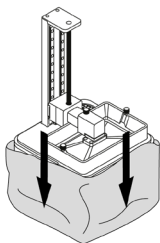

5. Remove the foil.

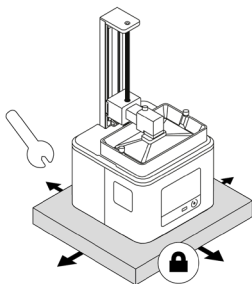

6. Place the printer on a flat and stable surface. If the printer remains uneven, use the plastic wrench from the Starter Kit to tighten or loosen the printer's legs as needed.

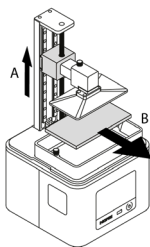

7. Move up the platform by gripping the platform block and pulling it upward (A). Remove the cushioning (B).

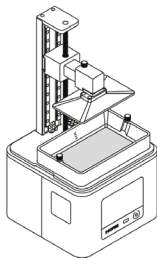

8. Clean the FEP film inside the resin tank with a cloth.

zortrax

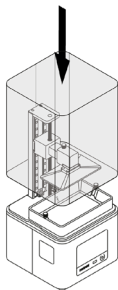

9. Remove the foil from the UV cover. Install the cover on the printer.

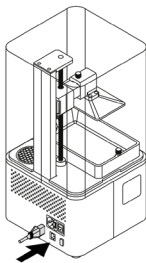

10. Plug in the power cable and turn on the printer. Connect it to a network via Wi-Fi or Ethernet. Go to *Settings* and configure the connection using options from the menu.

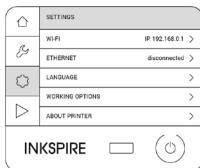

11. If the printer is connected to a network, select *Settings* -> *About Printer* -> *Check for updates* to check if there is a newer firmware version available. If so, follow the instructions displayed on the screen.

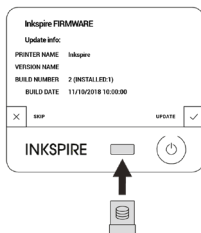

12. If the printer isn't connected to a network, go to <https://support.zortrax.com/downloads/> and check if there is a firmware update available. If so, download the file and save it on the USB drive. Plug the USB drive into the port at the front to start the installation.

🏠	TOOLS	
	MATERIAL	Z-RESIN >
🌀	PLATFORM	>
⚙️	CALIBRATION	>
	LAMP TEST	>
▶️	FANG TEST	⏪ ● ⏩

13. To calibrate the platform, select *Tools* -> *Calibration*. Follow the instructions displayed on the screen.

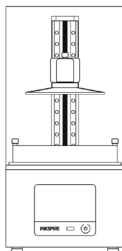

14. You have finished the set-up. Your device is ready to print.

Connecting the printer to a network



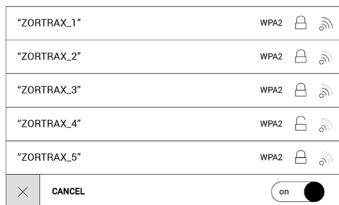
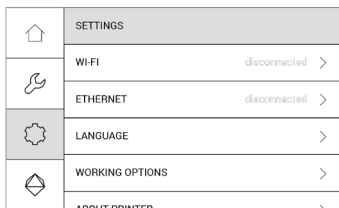

The Zortrax Inkspire can be connected to a local network in two ways: via Wi-Fi or an Ethernet cable. Both methods allow you to manage the printer directly from Z-SUITE and make it possible to remotely transfer .zcodex files from your computer to the printer.

To connect the printer to a Wi-Fi network, open the *Settings* menu and select *Wi-Fi*. From the list of available networks, choose your network and if it's required, enter the password. Select *Connect* to establish the connection.



SSID	"ZORTRAX_1"
FORGET	✕
IP ADDRESS	192.168.0.1
MANUAL IP	<input checked="" type="checkbox"/> off
IP ADDRESS	<input type="text"/>
✕	CANCEL
CONNECT	▶

To connect the printer with an Ethernet cable, create a local network and connect the router/modem/switch to the printer. The connection will be established automatically. You can control the Ethernet connection settings in the main menu; select *Settings* and *Ethernet*.

	SETTINGS
	WI-FI disconnected >
	ETHERNET IP : 192.168.0.1 >
	LANGUAGE >
	WORKING OPTIONS >
	ABOUT PRINTER >

ETHERNET CARD	<input checked="" type="checkbox"/> on
IP ADDRESS	192.168.0.1
MAC ADDRESS	aa.bb.cc.dd.ee.ff
MODE	DHCP
IP ADDRESS	<input type="text"/>
✕	CANCEL
CONFIRM	✓

Once your printer is connected to the network, open the *My Devices* panel in Z-SUITE. You can search for devices available in the local network and add them to the program's panel. Select the icon with your printer's IP address and click on it to add the printer to the panel. You can also add a printer manually by typing its IP address.

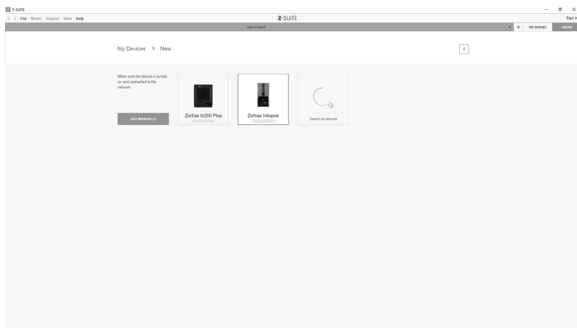
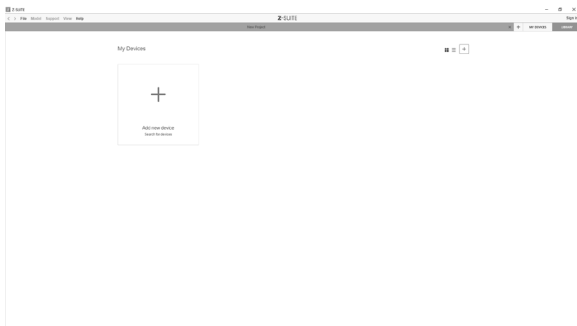

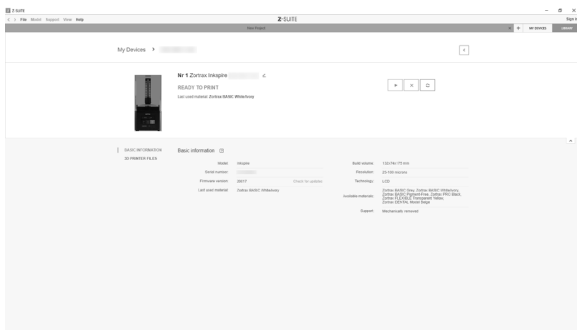

Each added printer can easily be managed in Z-SUITE. You can start, stop and pause the printing process, see the printer's current state (*Ready to Print / Printing / Paused / Offline*), change the name of your printer, or preview basic information about the printer.

In the 3D Printer Files tab, you can preview all .zcodex files that are stored on the printer's USB flash drive.

Firmware Update

If your printer is connected to the Internet using either Wi-Fi or an Ethernet cable, it automatically checks for available firmware updates and starts the installation process. You can also check if there is a newer firmware version available at any point of working with the Zortrax Inkspire and update the firmware. Select *Settings* -> *About Printer* -> *Check for updates*.

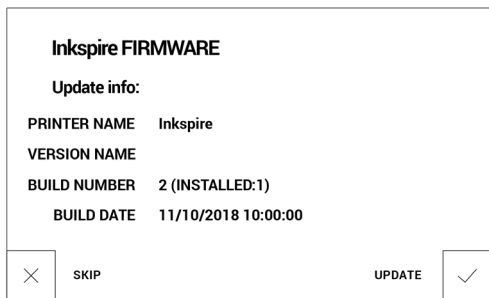

If you have decided not to connect the printer to the Internet, check <https://support.zortrax.com/downloads/> regularly for updates. To update the firmware, transfer the Update.zar2 file to a USB flash drive and plug the USB drive to the port at the front of the device to start the installation.

Navigating through the Menu

The main menu is divided into four submenus: *HOME*, *TOOLS*, *SETTINGS* and *PRINT*. Navigating through the menus and activating or deactivating the printer's functions and settings is possible through the touchscreen.

The *HOME* menu displays all relevant information about the printer and its current state: IP address, the type of connection to a local network (Wi-Fi or Ethernet), the type of resin poured into the tank, and storage used on the USB flash drive.

The *TOOLS* menu contains several options useful during the printing process and maintenance work:

Material - this option allows you to choose the type of resin you're going to use.

Platform - this option allows you to change the position of the platform. You can either move the platform (up or down) or set it in the home position.

Lamp test - this option allows you to check the UV lamp for proper operation.

Calibration - this option activates the procedure of platform calibration.

Fans test - this option allows you to check the printer's fans for proper operation.

Resin level control - this option allows you to enable/disable the resin level control visible on the screen when filling the tank.

The *SETTINGS* menu allows you to configure the printer according to your preferences:

Wi-Fi - this option allows you to connect the printer to a local network.

Ethernet - this option allows you to control the Ethernet connection settings.

Language - this option allows you to change the language of the menu.

File sorting - this option allows you to organize saved files by the date or in an ascending order.

About printer - this tab contains information which identifies the printer model, its firmware and hardware version, and serial number.

Select *Print* to choose a model for printing and start the printing process. The printer will display all information concerning the process on the screen.

Changing the Resin

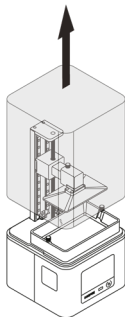

1. From the menu select *Tools, Platform and Move the platform*. Keep the *UP* arrow pressed to lift the platform. Next, remove the UV cover.

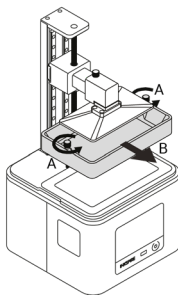

2. Loosen the two screws that secure the resin tank (A). Next, remove the tank (B).

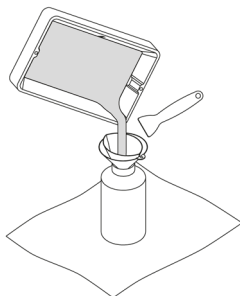

3. Insert the resin filter into the silicone funnel and put them together in the bottle with resin. Pour the resin left in the tank through the filter and funnel. If it is necessary, use a plastic spatula.

Once you finish, clean the resin filter in a liquid detergent or isopropyl alcohol. If it's necessary, you can also clean the resin tank using the same liquid.

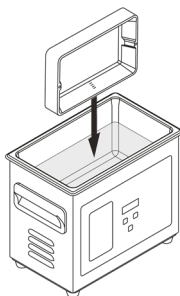

4. Put the resin tank in the Ultrasonic Cleaner and turn on the device for about 30-60 seconds.

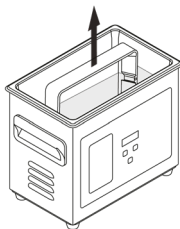

5. Turn off the Ultrasonic Cleaner, remove the resin tank and leave it to air dry.

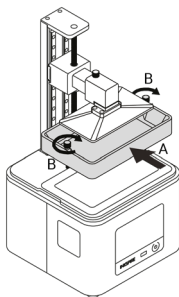

6. Clean the LCD screen. Once the resin tank is dry, install it back in the printer (A) and secure it with the screws (B).

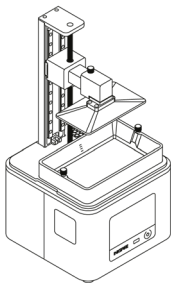

7. To calibrate the platform, select *Tools -> Calibration*. Follow the instructions displayed on the screen.

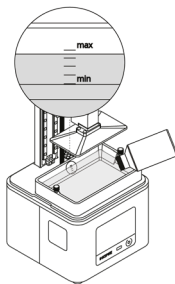

8. Fill the tank with resin. The resin level must fit the MIN and MAX marks.

zortrax

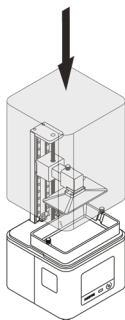

9. Install the UV cover on the printer.

Platform Calibration

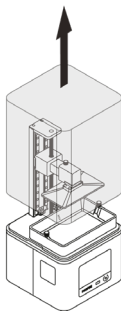

1. Remove the UV cover.

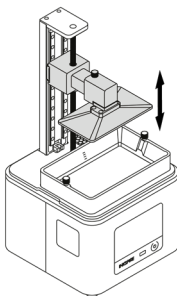

2. Start the calibration with the options from the menu. Select *Tools* and then *Calibration*. At this point the printer will start to lift up the platform.

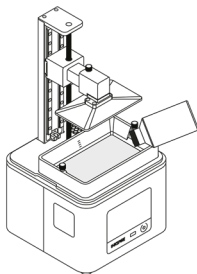

3. Pour a small amount of resin into the tank so that there is a thin layer of resin on the FEP film. Tap *Next* to confirm.

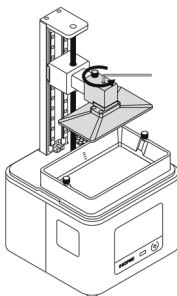

4. Loosen the platform screw with an Allen key. Tap *Next* to continue.

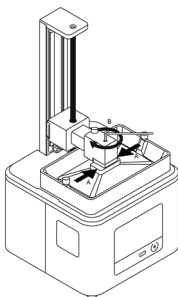

5. Hold the platform block in the places indicated in the graphic and tighten the platform screw. Make sure that the platform properly adheres to the LCD screen.

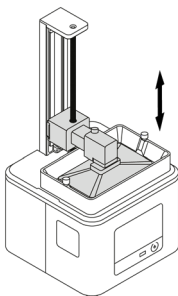

6. Once you finish the platform calibration, tap *Next* to calibrate the platform offset. This procedure ensures that the platform will be placed at the correct distance from the LCD screen during the printing process.

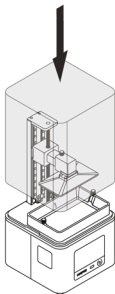

7. Install the UV cover back on the printer once all procedures are finished.

Z-SUITE Installation

The latest Z-SUITE update can be found in the Downloads section at: <https://support.zortrax.com>. To download and install Z-SUITE, you need to enter your printer's serial number. This number can be found in the printer's menu: *Settings* -> *About Printer*, and on the nameplate at the back of the printer.

Remember to update Z-SUITE regularly. All updates are available at: <https://support.zortrax.com/downloads/>.

Starting, Post-Processing and Removing a Print

Caution

Wear gloves and glasses during all procedures.

Prepare paper towels and keep them in your workplace for wiping up liquids.

Note

Printing and post-processing waste, including empty bottles, failed prints, supports, rafts as well as paper towels with resin residues should be put in the UV Station or in any source of UV light before disposal. Uncured resin has to be disposed of in accordance with national and local regulations concerning hazardous waste.

Detailed information regarding usage and waste disposal of the liquid detergent utilized to clean 3D prints should be found in the SDS delivered by the producer of the liquid.

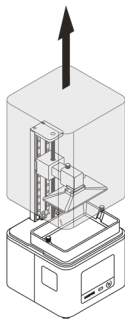

1. Remove the UV cover. If you haven't calibrated the platform during the set-up of the printer, carry out this procedure now.

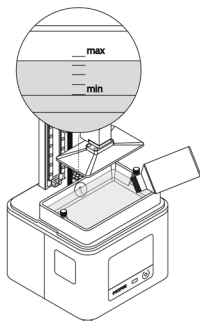

2. Fill the tank with resin. The resin level must fit the MIN and MAX marks. Install the UV cover back on the printer. Select the resin level on the diagram visible on the screen.

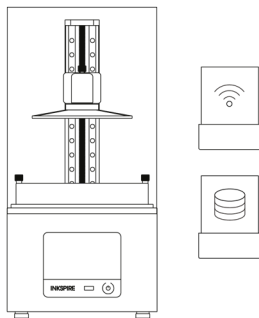

3. Transfer the file from Z-SUITE to the printer (via Wi-Fi/Ethernet or using the USB drive) and start the printing process.

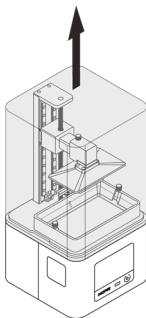

4. Once the printing process is finished, wait until the resin fully drains off of the model. Remove the UV cover.
*Depending on the size and geometry of the model, you can use the platform rotating jig from the Starter Kit to save more liquid resin.

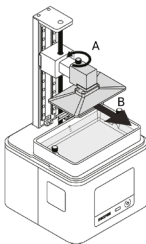

5. Wipe the top and edges of the platform with a paper towel and unscrew the platform screw (A). Remove the platform (B). Be careful not to spill the liquid resin on the printer and its surroundings. Install the UV cover on the printer.

zortrax

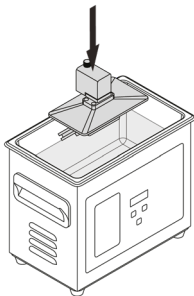

6. Immediately put the platform with the model in the Ultrasonic Cleaner. The model cannot be exposed to the UV light. Turn on the device. Cleaning time depends on the size of the model, but it shouldn't exceed three minutes. Longer cleaning time causes the liquid to heat up.

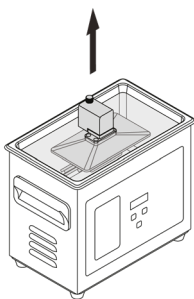

7. Turn off the Ultrasonic Cleaner and remove the platform with the model.

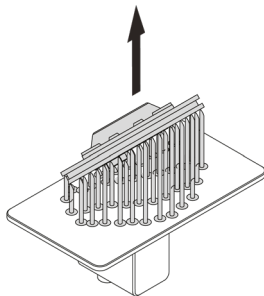

8. Leave the platform with the model to air dry and ensure that the model isn't exposed to the UV light until it's completely dry. You can use compressed air for better and faster drying. Next, remove the model from the platform by hand or use a spatula. If you have problems with removing the print, use a cutting knife.

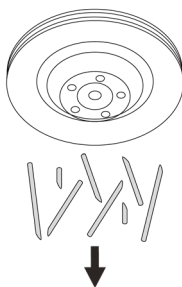

9. Remove the raft and support structures from the model.

zortrax

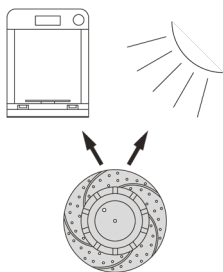

10. Put the model in the UV Station or in any source of UV light (e.g. direct sunlight).

*Depending on the type of resin you've used for printing, this step is optional.

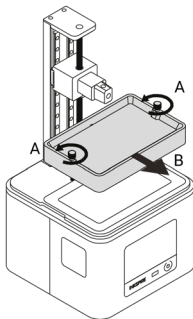

11. Unscrew the two screws that secure the resin tank and remove them (A). Next, remove the resin tank (B). Be careful not to spill the resin.

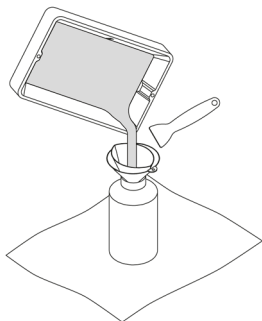

12. Insert the resin filter into the silicone funnel and put them together in the bottle with resin. Pour the resin left in the tank through the filter and funnel. If it's necessary, use a plastic spatula.

NOTE! It is advisable to filter the already used resin after each print. Mix it with the fresh resin to make sure that there are no cured remains in the liquid, as they could have a negative influence on the quality of the next print. Mixing used and fresh resin also helps to extend the resin lifespan.

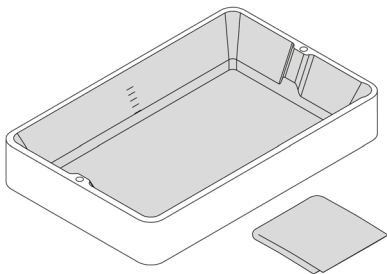

13. Clean the resin tank with a paper towel. You can also use 99% isopropyl alcohol for that purpose.

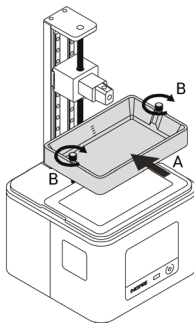

14. Clean the LCD screen and the outside of the FEP film with a soft cloth. Install the resin tank back in its place (A) and secure it with the two screws (B).

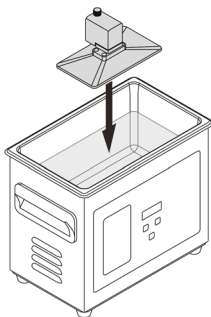

15. Clean the platform surface with a spatula to remove the residues of cured resin. Next, put the platform in the Ultrasonic Cleaner and turn on the device for about 30-60 seconds.

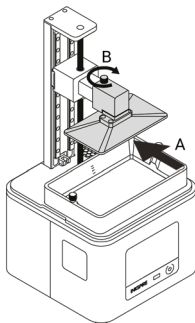

16. Turn off the Ultrasonic Cleaner, remove the platform and leave it to air dry. Once the platform is dry, install it back in the printer (A) and secure it with the screw (B).

Available Materials

The complete offer of materials is available at: <https://zortrax.com/resins/>.

Material Technical Data Sheets and *Safety Data Sheets* can be found at the same website.

When 3D printing with the Zortrax Inkspire, the Manufacturer recommends using Zortrax certified materials to acquire the best possible quality of prints.

Basic Maintenance and Service Work

Maintenance work should be regular in order to keep the printer in good condition and achieve high quality prints every time. Some parts require maintenance before each print and some every few hundred working hours. All maintenance activities do not take much time and are not complicated. Before commencing any repair, it is important to turn off the printer and let it cool down. Remember to always wear gloves and glasses.

The printer is delivered with a full set of tools needed to carry out maintenance service work.

The following tables present maintenance and repair guidelines connected with each section of the Zortrax Inkspire, together with specific check points, necessary activities and their frequency.

1. Main

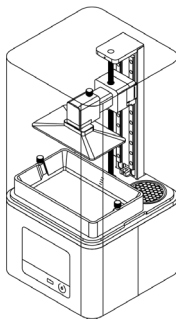

Activity	Frequency	Solutions to the problems	Necessary accessories
Cleaning the machine, its interior and surroundings	Before each printing process	Remove dust and drops of resin from the machine with paper towels. If it's necessary, use IPA.	-paper towels, -IPA, -safety gloves
Checking the degree of wear of the carbon filter and if it's necessary, cleaning it	Every 500 working hours	-	-
Replacing the filter	Every 3-4 months	The filter is installed in the back right corner of the printer's housing.	-a new filter
Cleaning the LCD screen	Every time the resin tank is removed	Soak a paper towel in IPA and clean the LCD screen.	-paper towels, -IPA, -safety gloves
Cleaning the UV cover	Once a week	Clean the cover from dust using a soft cloth. NOTE! Do not use IPA or chemical detergents for that purpose.	-a soft cloth

2. Hotend

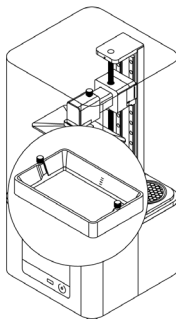

Activity	Frequency	Solutions to the problems	Necessary accessories
Cleaning the underside of the FEP film	Every time the resin tank is removed	Soak a paper towel in IPA and clean the underside of the FEP film.	-paper towels, -IPA, -safety gloves
Checking if there are residues of cured resin in the tank	Before each printing process	Use a plastic spatula and slightly mix the resin to check if there are any residues in the liquid.	-a plastic spatula, -safety gloves
Checking if there are residues of cured resin on the FEP film	Before each printing process	Empty the resin tank. If there are any residues of cured resin on the FEP film, remove them using a plastic spatula.	-a plastic spatula, -safety gloves
Emptying and cleaning the resin tank	Every time the resin type or color is changed	Insert the resin filter into the silicone funnel and pour the resin left in the tank into the bottle. Follow the instructions in the manual: https://support.zortrax.com/resin-tank-cleaning/	-resin filter, -silicone funnel, -bottle of resin, -paper towels, -a plastic spatula, -Ultrasonic Cleaner (optional)
Replacing the FEP film	Once the FEP film becomes bent, deformed, or perforated	Follow the instructions in the manual: https://support.zortrax.com/fep-film-replacement/	-a new FEP film, -a screwdriver, -paper towels, -IPA, -safety gloves

3. Platform

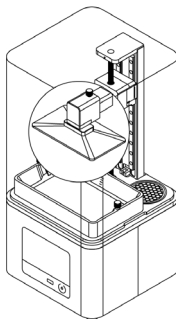

Activity	Frequency	Solutions to the problems	Necessary accessories
Cleaning the platform	Before each printing process	Cured resin should be removed using a spatula. Liquid resin should be removed using a paper towel.	-spatula, -paper towels, -Ultrasonic Cleaner (optional)
Calibration	After each failed print or after three completed printing processes	Adjust the platform's position and tighten the platform screw. The platform has to properly adhere to the LCD screen. Follow the instructions in the manual: https://support.zortrax.com/platform-calibration-inkspire/	-

Support and Troubleshooting

In order to ensure safety of every 3D printer's user, the Manufacturer provides various support while identifying and solving technical problems independently.

In case of difficulties with operating a Zortrax 3D printer, at first you should seek guidance in this User Guide, check the manuals available at: <http://support.zortrax.com/>, or consult our technical specialists through the Support Form available at: <http://support.zortrax.com/support-form/>.

The most common problems are listed below along with the list of possible solutions.

The print does not adhere to the platform during the printing process:

1. Make sure that the model has been designed properly and its mesh does not contain any errors.
2. Make sure that while preparing the file in Z-SUITE you chose an appropriate printing profile, that is, the print settings match the type of used resin. If the profile is correct, increase the *Layer Exposure Time* in Z-SUITE or in the printer's menu during the printing process.
3. Make sure that both the platform and the FEP film are clean, that is, there are no residues of cured resin on them. Filter the already used resin and mix it with the fresh resin to make sure that there are no cured remains in the liquid.
4. Carry out platform calibration again.
5. Prepare a sheet of sandpaper (grit >160) and put it on a flat surface. Place the platform on the paper and smooth its surface in a circular motion.
6. Check if the FEP film is not bent, deformed, or perforated. Replace the FEP film if you notice such defects.
7. Contact the Support Center at: <http://support.zortrax.com/support-form>.

The print delaminates or it does not adhere to the support structures:

1. Make sure that the model has been designed properly and its mesh does not contain any errors.

2. If the support structures have been generated in a different program than Z-SUITE, make sure that the model's mesh is fixed.
3. Make sure that the print has been properly prepared in Z-SUITE, that is, its big and flat surfaces have been arranged at an angle. Each layer that will be parallel to the platform has to be as small as possible to be printed successfully.
4. Make sure that while preparing the file in Z-SUITE you chose an appropriate printing profile, that is, the print settings match the type of used resin. If the profile is correct, enable *Additional support exposure time* option and decrease the *Platform lift speed* in the Advanced settings menu.
5. Check if the FEP film is not bent, deformed, or perforated. Replace the FEP film if you notice such defects.
6. Contact the Support Center at: <http://support.zortrax.com/support-form>.

Error Messages

Whenever there is a technical issue caused by a hardware failure, negligence or inappropriate use of Zortrax printers, the firmware immediately displays an error message on the screen. The following list explains all error messages and provides potential causes and suggested solutions.



Error Message	Potential Cause	Suggested Solution
Error #1 LCD screen not connected	LCD screen control system error.	Check if the the HDMI and LCD cables are connected. If the problem reoccurs, contact Zortrax Support Center through the support form: https://support.zortrax.com/support-form/ .
Error #3 Unable to continue printing	Control board communication error.	Contact Zortrax Support Center through the support form: https://support.zortrax.com/support-form/ .
Error #4 Communication issue with LCD screen (HDMI signal)	LCD screen control system error.	Check if the the HDMI and LCD cables are connected. If the problem reoccurs, contact Zortrax Support Center through the support form: https://support.zortrax.com/support-form/ .

zortrax

Error #5 Wrong lamp temperature	Temperature of the UV lamp is too high. The cooling fan may be faulty.	Contact Zortrax Support Center through the support form: https://support.zortrax.com/support-form/ .
Error #6 An unexpected error occurred	An unexpected error has occurred in the application.	Contact Zortrax Support Center through the support form: https://support.zortrax.com/support-form/ .
Error #7 No firmware detected	There is no firmware installed in the printer.	Download the latest firmware update from https://support.zortrax.com/downloads/ . Transfer the update.zar2 file to a USB flash drive. Plug the USB into the port at the front of the printer and select <i>Refresh</i> to start the installation.
Error #8 Unable to communicate with control board	No connection with the control board.	Contact Zortrax Support Center through the support form: https://support.zortrax.com/support-form/ .
Error #9 Fan error	The UV lamp fan has failed.	Contact Zortrax Support Center through the support form: https://support.zortrax.com/support-form/ .
Error #10 Communication issue with LCD screen (IC error)	LCD screen control system error.	Check if the the HDMI and LCD cables are connected. If the problem reoccurs, contact Zortrax Support Center through the support form: https://support.zortrax.com/support-form/ .
Error #11 Endstop error	The printer is unable to detect the endstop.	Check if the endstop is functioning properly. Tighten the endstop screw placed on the guideway fixed block. If the problem reoccurs, contact Zortrax Support Center through the support form: https://support.zortrax.com/support-form/ .
Error #12 Cannot print this model - it's too tall	The model exceeds the acceptable dimension in the Z-axis.	Prepare the model again in ZSUITE.
Error #14 Temperature sensor broken or not connected	The temperature sensor has failed or may be disconnected.	Check if the temperature sensor is properly connected. If the problem reoccurs, contact Zortrax Support Center through the support form: https://support.zortrax.com/support-form/ .
Error #15 Cannot update the firmware	An error has occurred while updating the firmware.	Contact Zortrax Support Center through the support form: https://support.zortrax.com/support-form/ .

zortrax

Error #17 Communication issue with LCD screen (TE signal)	LCD screen control system error.	Check if the the HDMI and LCD cables are connected. If the problem reoccurs, contact Zortrax Support Center through the support form: https://support.zortrax.com/support-form/ .
Error #18 Firmware malfunction	Control board error.	Download the latest firmware update from https://support.zortrax.com/downloads/ . Transfer the update.zar2 file to a USB flash drive. Plug the USB into the port at the front of the printer and select Refresh to start the installation.

	If the device begins to operate in an unidentified way, safely unplug the printer from the power supply and immediately contact the Support Center specialists via the support form at: http://support.zortrax.com/support-form/ .
	While shipping the device to the Manufacturer's technical service, it is extremely important to properly pack the printer. Use the original packaging. Detailed instructions on how to pack the device are available at: http://support.zortrax.com/inkspire-packing/ .

More manuals and tips & tricks articles are available at our Support Center.

www.zortrax.com

Specification

Weight and Physical Dimensions	
Device (W x D x H)	210 x 210 x 420 mm (8.3 x 8.3 x 16.5 in)
Shipping box	315 x 312 x 530 mm (12.4 x 12.3 x 20.9 in)
Net weight	6.2 kg (13.7 lb)
Device weight	10.1 kg (22.3 lb)
Shipping weight	10.5 kg (23.1 lb)
Printing	
Technology	UV LCD
Layer thickness	25, 50, 100 microns
Print speed	20 - 36 mm/h
Device	
Build volume	74 x 132 x 175 mm (2.9 x 5.2 x 6.9 in)
Support	Mechanically removed - printed with the same material as the model
Light source	UV integrated light (wavelength 405 nm)
Connectivity	Wi-Fi, Ethernet, USB
Operating system	Android
Processor	Quad Core

zortrax

Touchscreen	4" IPS 800 x 480
Available materials	Full offer is available at: https://zortrax.com/resins/
External materials	Applicable
Temperature	
Ambient operation temperature	20 - 30° C (68 - 86° F)
Storage temperature	0 - 35° C (32 - 95° F)
Electrical	
AC input	110 V ~ 5.9 A 50/60 Hz; 240 V ~ 2.5 A 50/60 Hz
Maximum power consumption	75 W
Software	
Software bundle	Z-SUITE
Supported file types	.stl, .obj, .dxf, .3mf, .zcodex
Supported formats	.cws, .zcodex
Supported operating systems	Mac OS X / Windows 7 and newer versions
Additional information	
All information contained in this User Guide and specification is subject to change without notice.	

Recycling

Disposal of paper and plastic packaging

To protect the environment, the Manufacturer recommends placing used paper and plastic packaging in specially designated containers, according to your local recycling guidelines.

Disposal of resin

Printing and post-processing waste, including empty bottles, failed prints, supports, rafts as well as paper towels with resin residues should be put in the UV Station or in any source of UV light before disposal. Uncured resin has to be disposed of in accordance with national and local regulations concerning hazardous waste.

Detailed information regarding usage and waste disposal of the liquid detergent utilized to clean 3D prints should be found in the SDS delivered by the producer of the liquid.

Waste electrical and electronic equipment

This symbol indicates that it is electrical and electronic equipment which must not be disposed of with household waste. Substances contained in the equipment may be harmful to natural environment. Waste electrical and electronic equipment cannot be disposed of in landfills and must be recycled. For information on where to dispose of waste equipment, contact the reseller, the Manufacturer, or the importer of the device. Disposing of waste electrical and electronic equipment along with other waste is prohibited by the Directive 2012/19/UE.

Certification



The Manufacturer ensures that the equipment complies with all relevant standards. In case of questions and problems contact the Manufacturer through the support form: <http://support.zortrax.com/support-form/>.

zortrax

office: office@zortrax.com

technical support: support@zortrax.com

more information: zortrax.com

©2019 Zortrax S.A. All rights reserved.